



**INSTALLATION
MANUAL**

Walk in shower enclosure

ECO-N / ECO-N BLACK



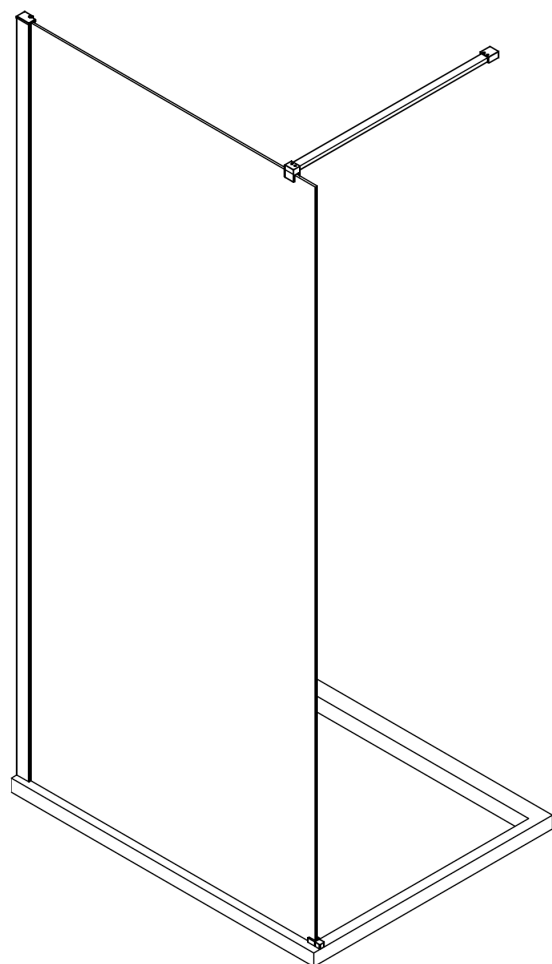



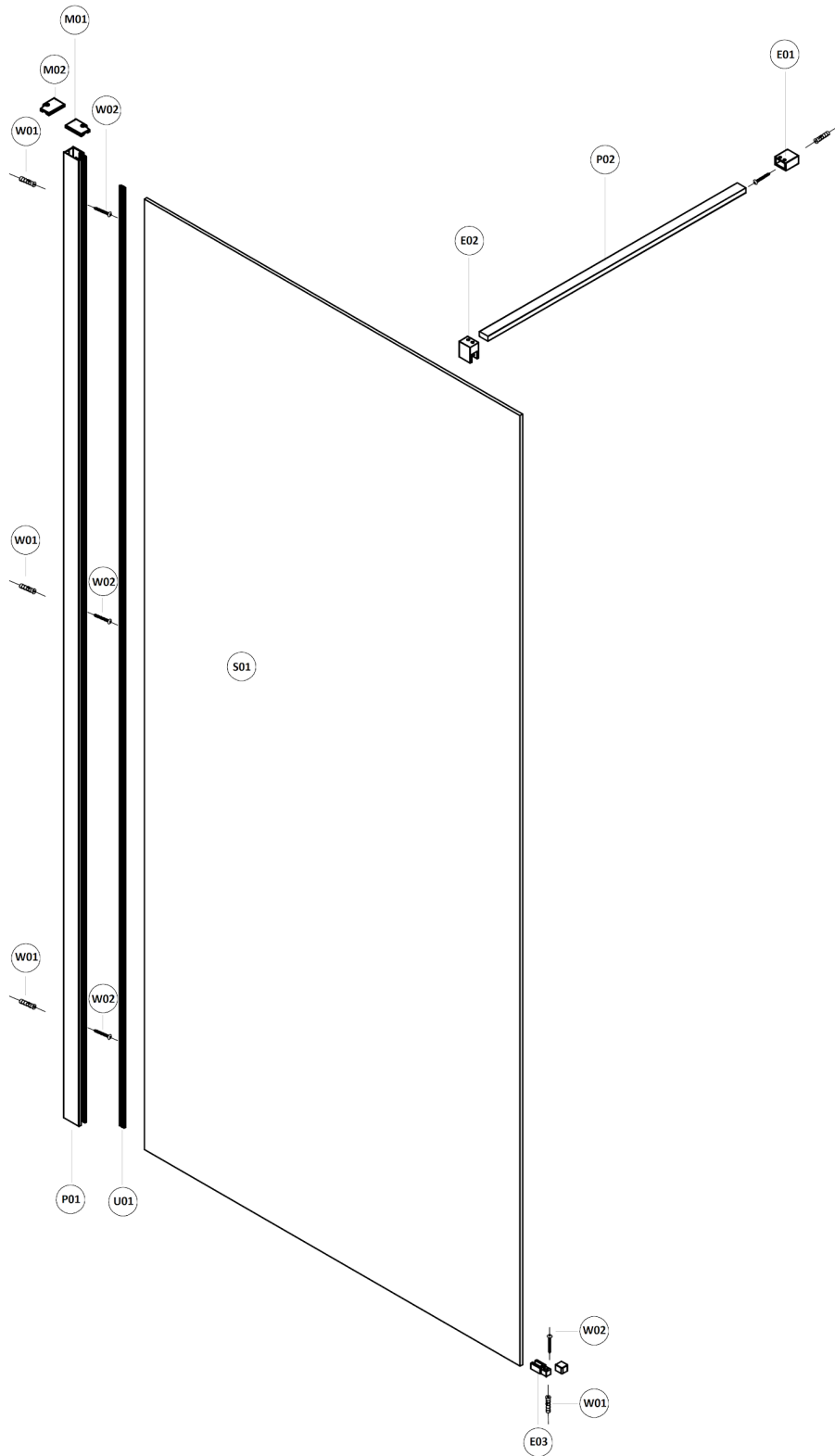

Models: EN-90-195C, EN-100-195C, EN-110-195C, EN-120-195C, ENB-90-195C, ENB-100-195C, ENB-110-195C, ENB-120-195C

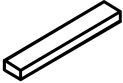





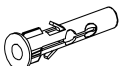

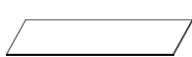
More information: www.besco.eu

besco

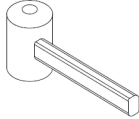
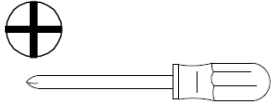

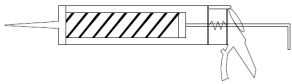
part number	description	IU	quantity	sketch
P01	Wall profile ECO-N / ECO-N BLACK	pcs.	1	
P02	Bracket ECO-N / ECO-N BLACK	pcs.	1	
U01	Seal ECO-N / ECO-N BLACK	pcs.	1	
M01	Cover / end cap for wall profile ECO-N / ECO-N BLACK, left	pcs.	1	
M02	Cover / end cap for wall profile ECO-N / ECO-N BLACK, right	pcs.	1	
E01	Wall mounting element for bracket ECO-N / ECO-N BLACK	pcs.	1	
E02	Glass mounting element for bracket ECO-N / ECO-N BLACK	pcs.	1	
E03	Bottom glass mounting element ECO-N / ECO-N BLACK	pcs.	1	
W01	Mounting wall plug, plastic	pcs.	5	
W02	ST4x40 screw	pcs.	5	
S01	Fixed flat glass ECO-N / ECO-N BLACK, clear	pcs.	1	

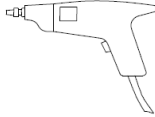
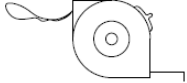
	P01	P02	U01	M01	M02	E01	E02	E03	W01	W02	S01
EN-90-195C	PSENP01C1 1950 mm chrome	PWENWP02C1 1200 mm chrome	UPENWU01P1 1950 mm clear	MBENWM01C1 chrome	MBENWM02C1 chrome	EWENWE01C1 chrome	EWENWE02C1 chrome	EWENWE03C1 chrome	WKENWW01D1	WRENWW02D1	SSENWS01P1 1950x875x6 mm
EN-100-195C	PSENP01C1 1950 mm chrome	PWENWP02C1 1200 mm chrome	UPENWU01P1 1950 mm clear	MBENWM01C1 chrome	MBENWM02C1 chrome	EWENWE01C1 chrome	EWENWE02C1 chrome	EWENWE03C1 chrome	WKENWW01D1	WRENWW02D1	SSENWS01P2 1950x975x6 mm
EN-110-195C	PSENP01C1 1950 mm chrome	PWENWP02C1 1200 mm chrome	UPENWU01P1 1950 mm clear	MBENWM01C1 chrome	MBENWM02C1 chrome	EWENWE01C1 chrome	EWENWE02C1 chrome	EWENWE03C1 chrome	WKENWW01D1	WRENWW02D1	SSENWS01P3 1950x1175x6 mm
EN-120-195C	PSENP01C1 1950 mm chrome	PWENWP02C1 1200 mm chrome	UPENWU01P1 1950 mm clear	MBENWM01C1 chrome	MBENWM02C1 chrome	EWENWE01C1 chrome	EWENWE02C1 chrome	EWENWE03C1 chrome	WKENWW01D1	WRENWW02D1	SSENWS01P4 1950x1275x6 mm
ENB-90-195C	PSENP01B1 1950 mm matt black	PWENWP02B1 1200 mm matt black	UPENWU01B1 1950 mm black	MBENWM01B1 matt black	MBENWM02B1 matt black	EWENWE01B1 matt black	EWENWE02B1 matt black	EWENWE03B1 matt black	WKENWW01D1	WRENWW02D1	SSENWS01P1 1950x875x6 mm
ENB-100-195C	PSENP01B1 1950 mm matt black	PWENWP02B1 1200 mm matt black	UPENWU01B1 1950 mm black	MBENWM01B1 matt black	MBENWM02B1 matt black	EWENWE01B1 matt black	EWENWE02B1 matt black	EWENWE03B1 matt black	WKENWW01D1	WRENWW02D1	SSENWS01P2 1950x975x6 mm
ENB-110-195C	PSENP01B1 1950 mm matt black	PWENWP02B1 1200 mm matt black	UPENWU01B1 1950 mm black	MBENWM01B1 matt black	MBENWM02B1 matt black	EWENWE01B1 matt black	EWENWE02B1 matt black	EWENWE03B1 matt black	WKENWW01D1	WRENWW02D1	SSENWS01P3 1950x1175x6 mm
ENB-120-195C	PSENP01B1 1950 mm matt black	PWENWP02B1 1200 mm matt black	UPENWU01B1 1950 mm black	MBENWM01B1 matt black	MBENWM02B1 matt black	EWENWE01B1 matt black	EWENWE02B1 matt black	EWENWE03B1 matt black	WKENWW01D1	WRENWW02D1	SSENWS01P4 1950x1275x6 mm

Recommended tools			
pencil		rubber hammer	
cross screwdriver		Ø3 mm drill	
clear sanitary silicone		Ø6 mm drill	
spirit-level		electric drill	
measuring tape (min. 2 meters)		hex key	

The most common mistakes made during assembly process:

- 1) The lack of proper surface levelling (shower tray)
- 2) Incorrect assembly of the glass panel in the wall profile - the glass, after being placed in the wall profile, should be parallel to the edge of the shower tray (with the ProClean coating side facing the inside)
- 3) Installation of so called "cold seal" - the seal should be stored at least 12 hours at room temperature before its assembly
- 4) Incorrect installation of the U01 seal - the serrated side should face the profile (not the glass)
- 5) Incorrect installation of the bracket - pay attention to the correct levelling and installation of the bracket in the right place on the glass (near the outer edge)

becco

INSTALLATION MANUAL

1

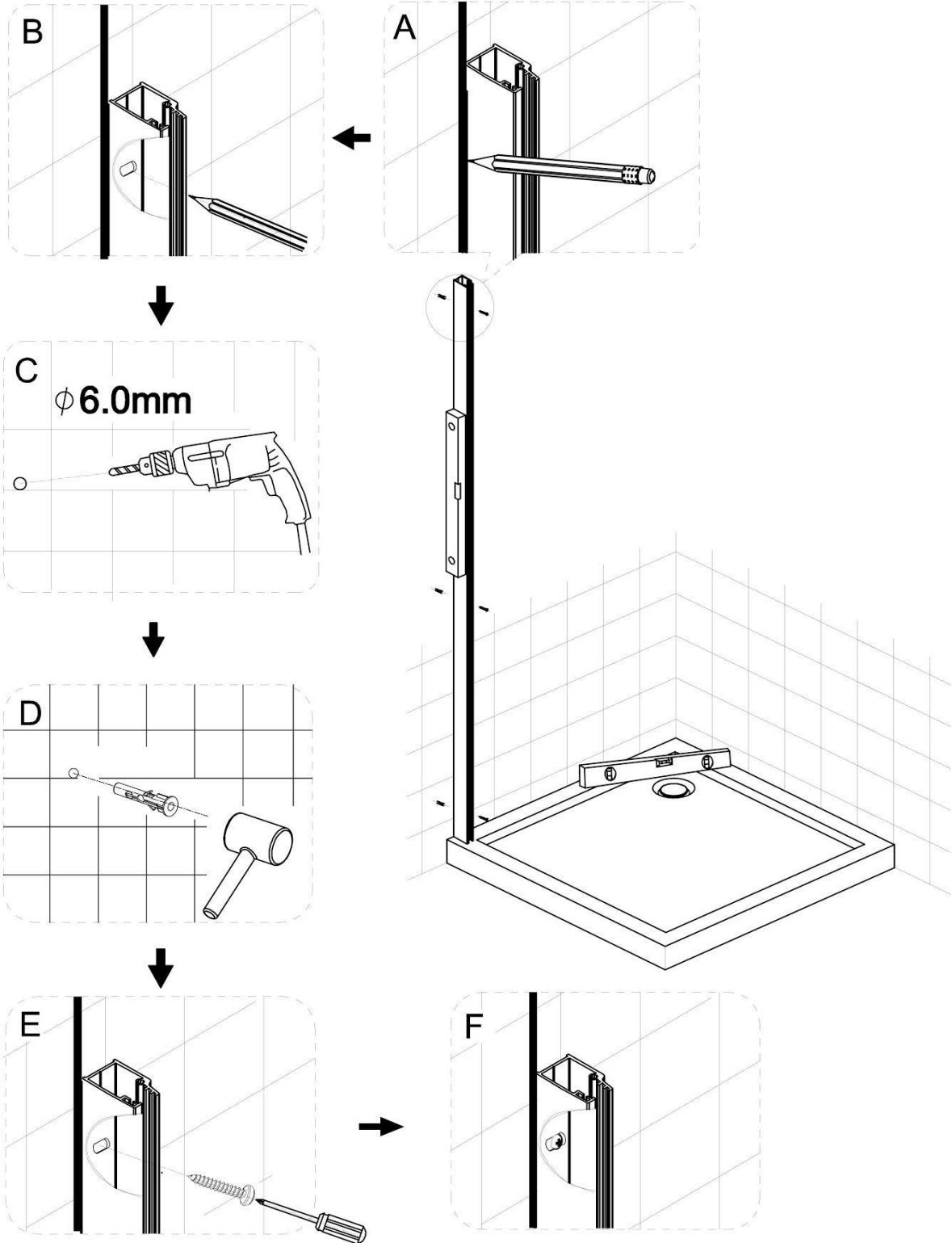

INSTALLATION MANUAL

2

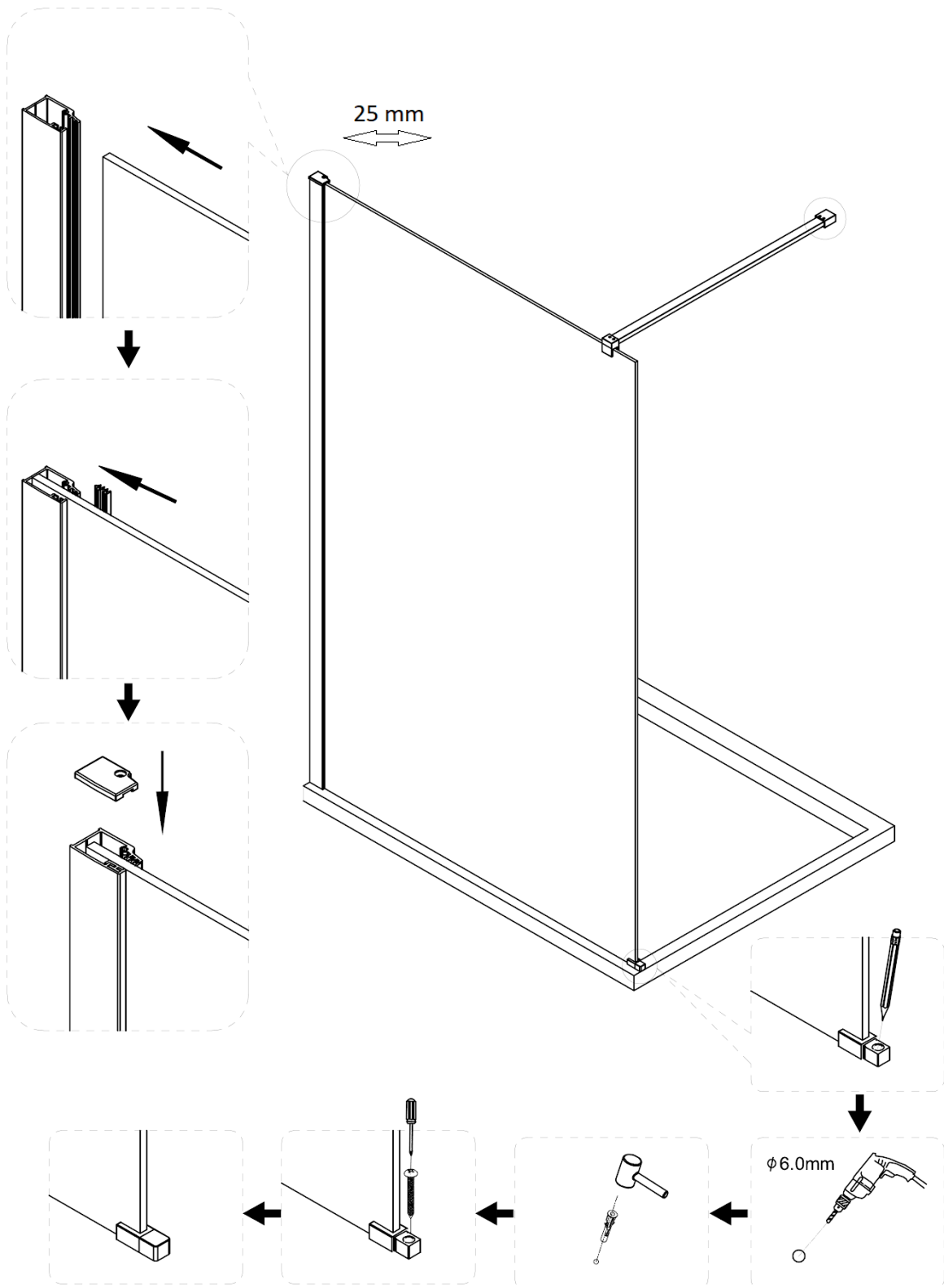

INSTALLATION MANUAL

3

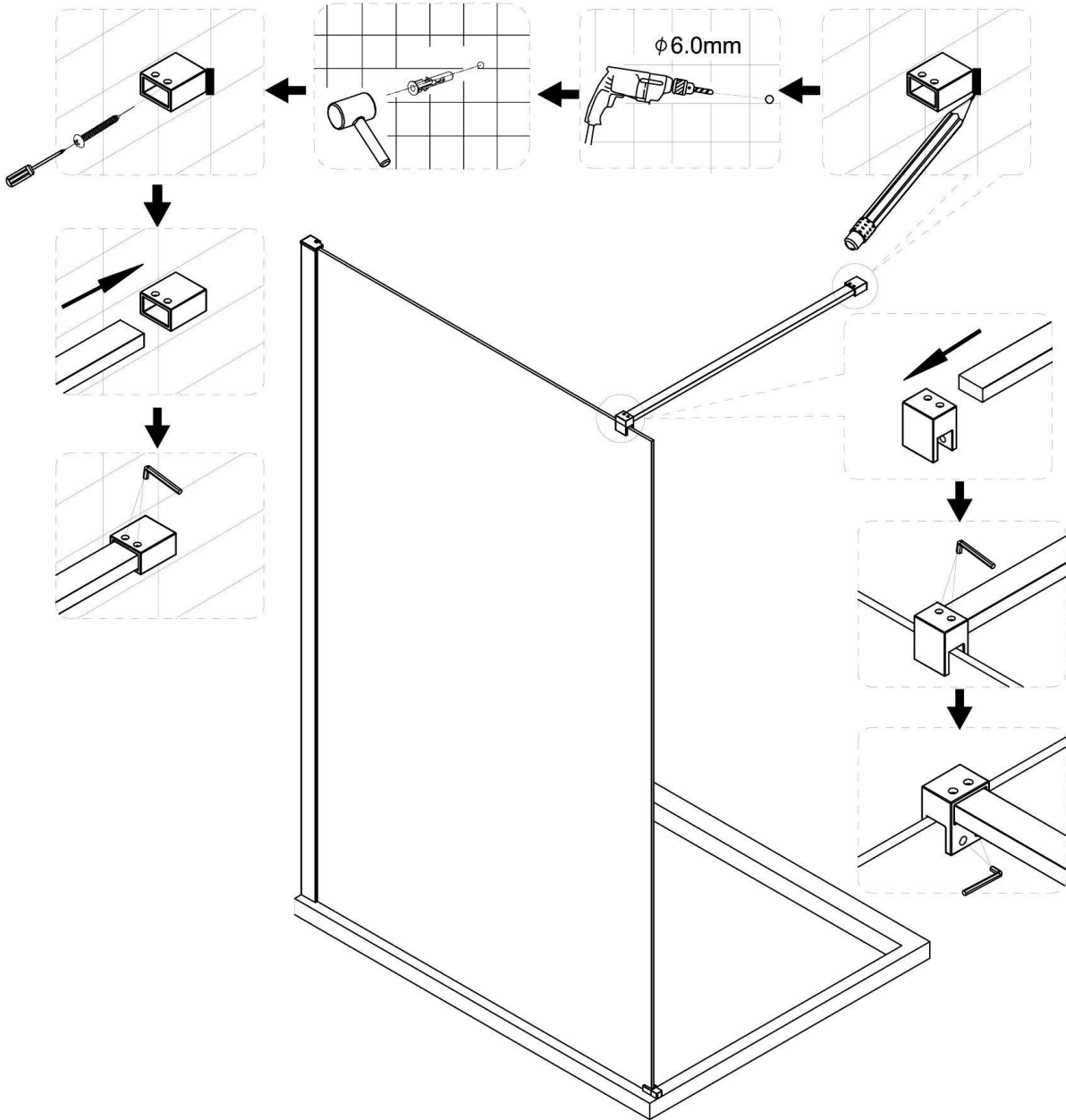

INSTALLATION MANUAL

4

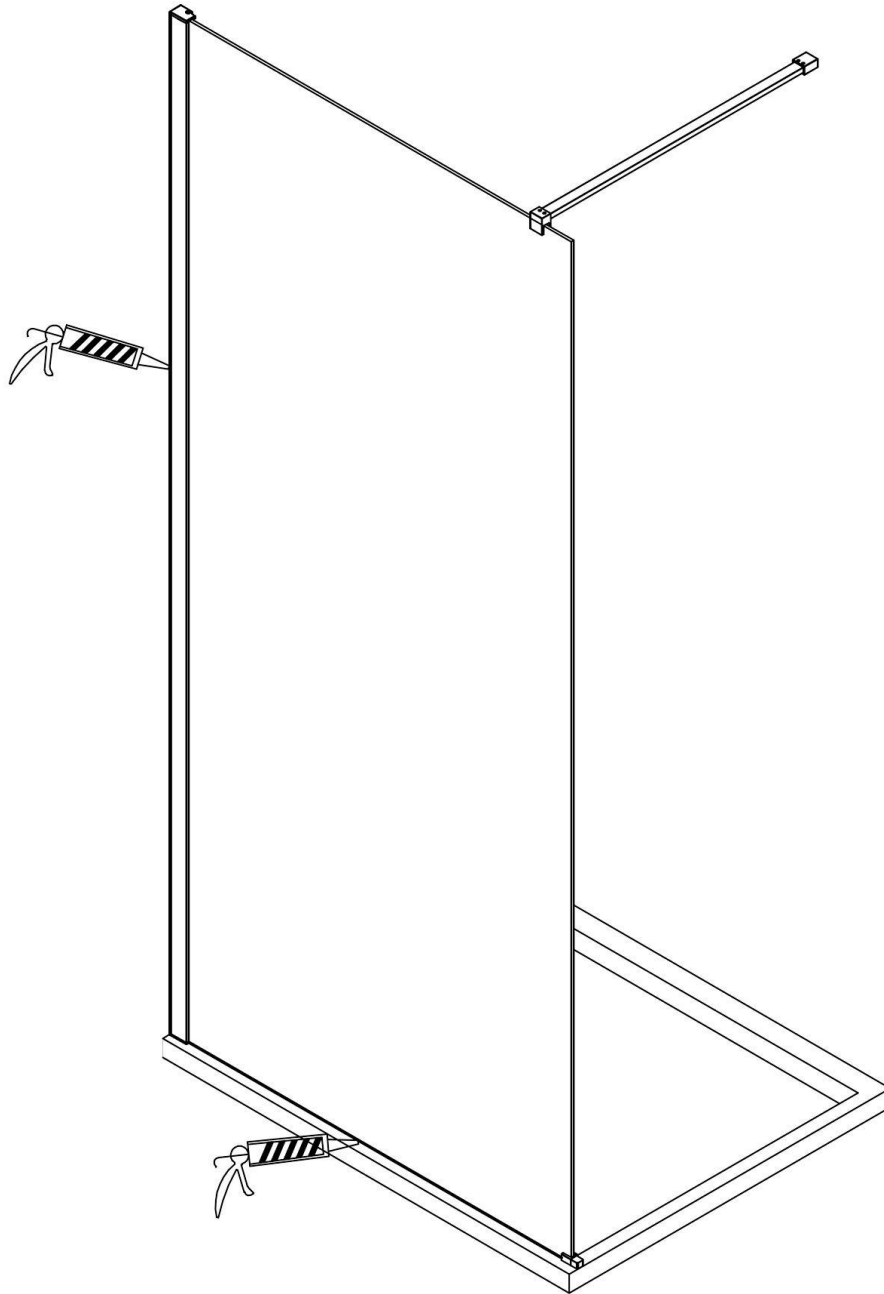

Recommendations regarding use:

After the installation of the shower enclosure is completed, the shower enclosure should not be used for at least 48 hours. Do not use caustic or abrasive substances for cleaning the shower enclosure.

Recommended care product: **Besco Professional "Shower enclosures & screens"**

How to maintenance Besco shower enclosures?

Just remember a few basic rules, to be able to enjoy your shower enclosure for many years.

It is important to use only soft sponges or cloths and liquids that do not contain corrosive substances or scrubbing particles, as they can easily damage the glass surface of the shower enclosure.

To make a daily care of our products a little bit easier and to ensure their comfortable use, we have introduced a professional cleaning agent for shower screens to our offer: **Besco Professional "Shower enclosures & screens"**

Contact details:

Besco Sp. z o.o.
Kościelna 21
38-524 Besko, Poland
VAT no: PL6871838293

M: +48 600 700 336
T: +48 13 467 34 44
e-mail: info@besco.eu

