

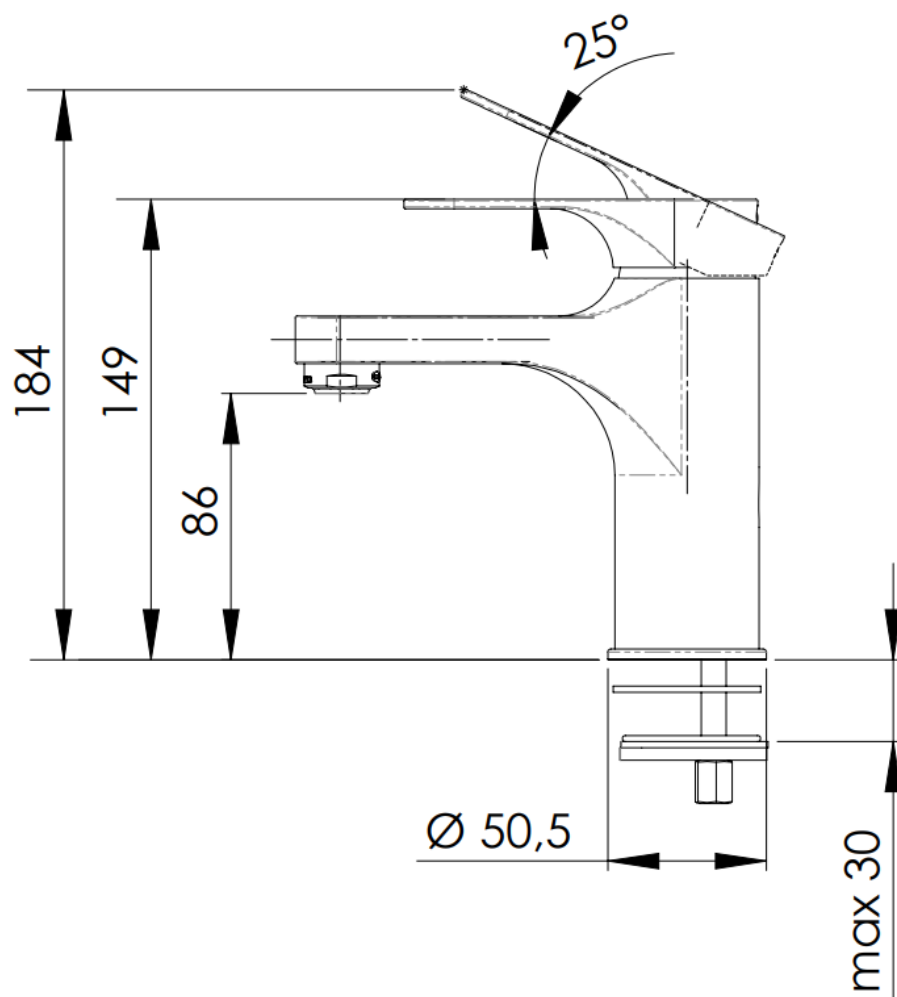

TECHNICKÝ VÝKRES

KÓD VÝROBKU:

L11

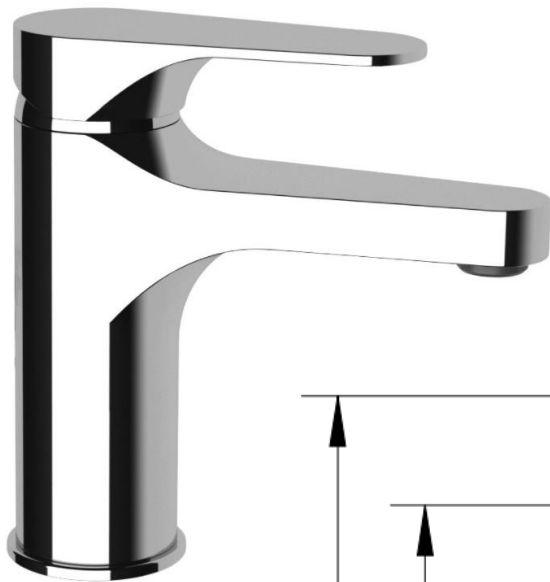

BARVA

CHROM

Nám. MUDr. J. Svobody 60, 28522 Zruč nad Sázavou – mob.: 603 177 127, tel.: 327 532 298

sanjet@sanjet.cz

www.sanjet.cz