

CREA

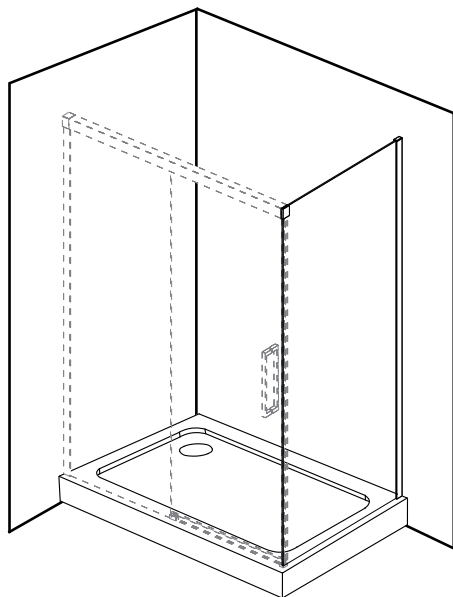

PL INSTRUKCJA MONTAŻU I EKSPLOATACJI

CZ NÁVOD NA MONTÁŽ A ÚDRŽBU

SK NÁVOD NA MONTÁŽ A ÚDRŽBU

EST PAIGALDUS- JA KASUTUSJUHEND

LT MONTAVIMO IR EKSPLOATAVIMO INSTRUKCIJA

LV MONTĀŽAS UN EKSPLUATĀCIJAS INSTRUKCIJA

DE MONTAGE- UND AUFBAUANLEITUNG

RO INSTRUCȚIUNI DE MONTAJ ȘI OPERARE

HU SZERELÉSI ÉS ÜZEMELTETÉSI ÚTMUTATÓ

UA ІНСТРУКЦІЯ З МОНТАЖУ І ЕКСПЛУАТАЦІЇ

BY ІНСТРУКЦЫЯ ПА МАНТАЖЫ І ЭКСПЛУАТАЦЫЇ

RU ИНСТРУКЦИЯ ПО МОНТАЖУ И ЭКСПЛУАТАЦИИ

EN INSTRUCTIONS FOR ASSEMBLY AND USE



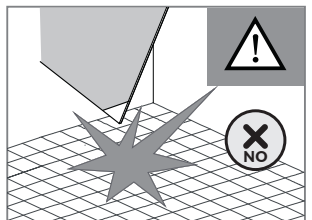
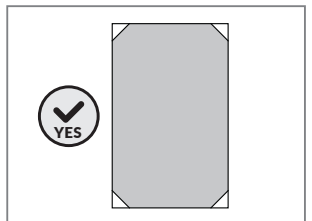
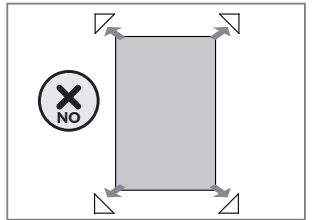
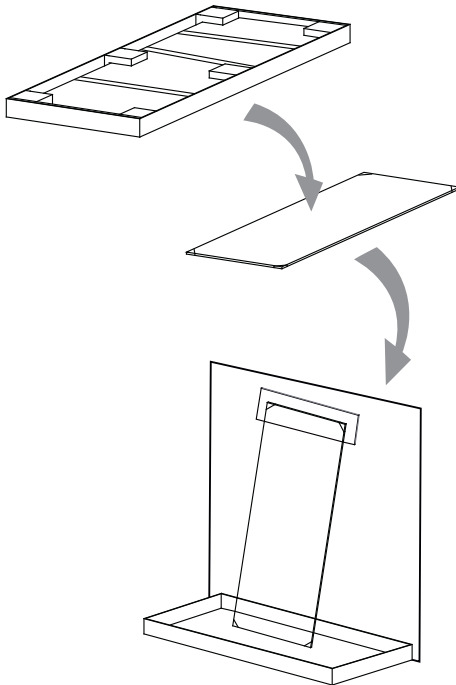
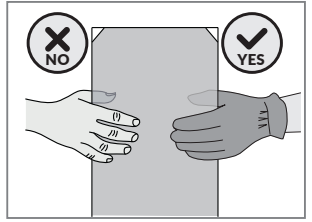
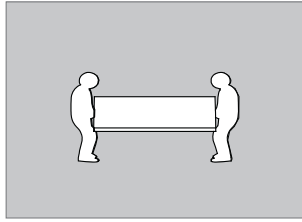
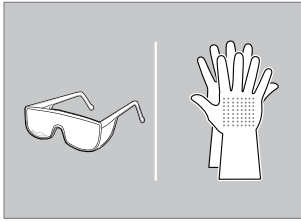
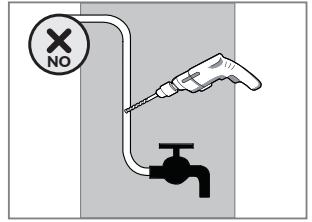
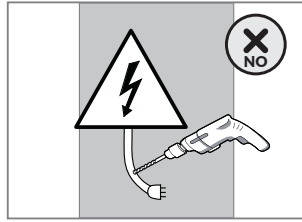
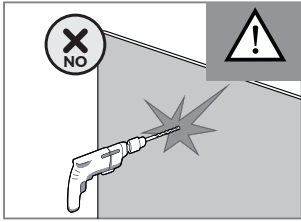

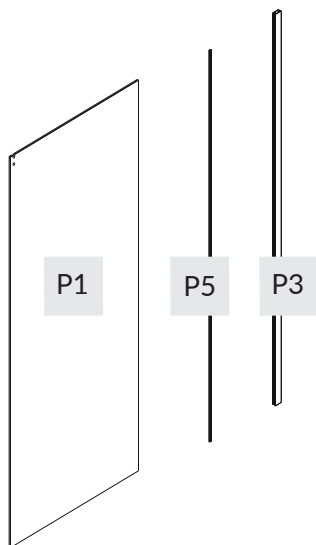
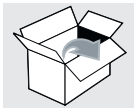

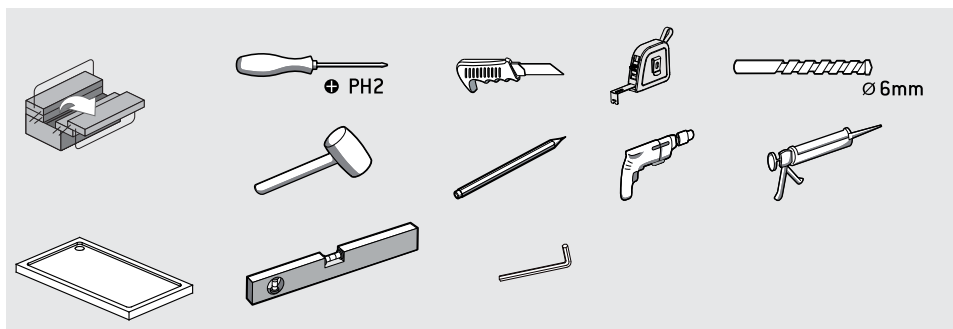
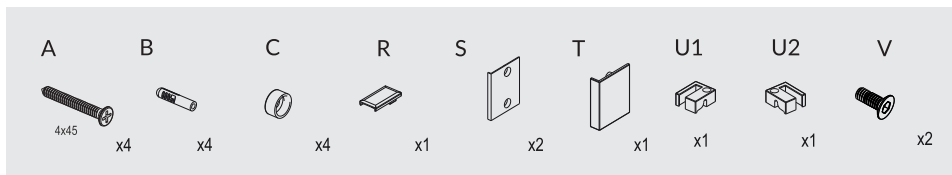

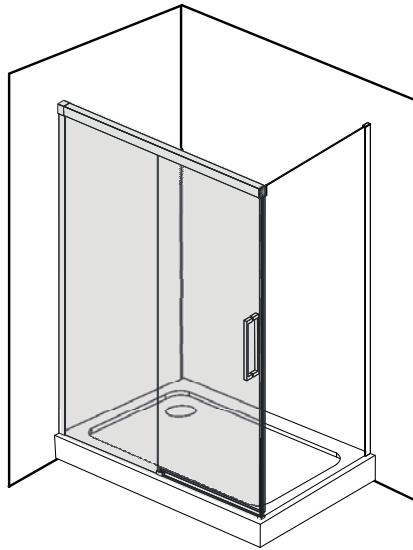
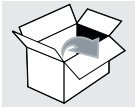















FR INSTALLATION ET UTILISATION – MODE









- | | | | | | | |
|---|--|--|--|---|--|---|
| A

4x45
x8 | B

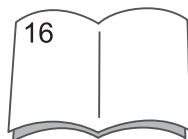
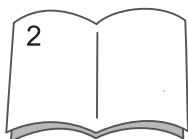
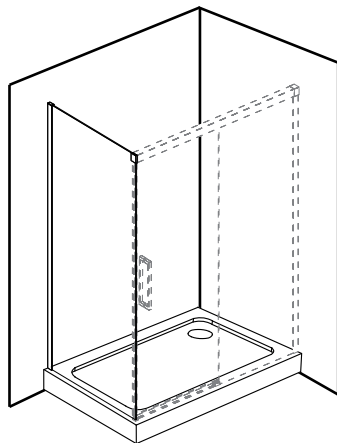
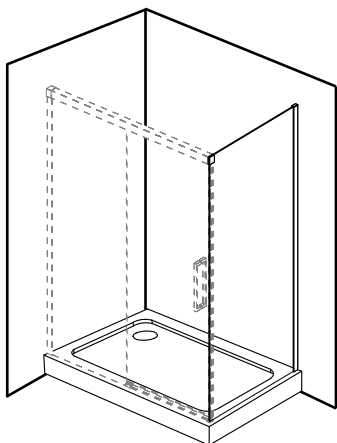
x8 | C

x4 | D

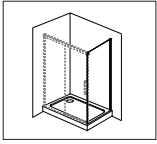
x1 | E

x1 | F

x1 | |
| G

x1 | H

x1 | I

x1 | J

x1 | K

x1 | L

x1 | |
| M1

x1 | M2

x1 | P

3.5x 12
x4 | N

x1 | F1

1mm
x4 | F2

2mm
x4 | F3

3mm
x4 |
| L1

x1 | L2

x1 | Q1

x1 | Q2

x1 | R

x1 | S

Ø PH2
x1 | |

1.



2.



SIZE	X(mm)	Y(mm)
1200X800X2000	780-800	1180-1200
1200X900X2000	880-900	1180-1200
1400X800X2000	780-800	1380-1400
1400X900X2000	880-900	1380-1400

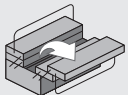
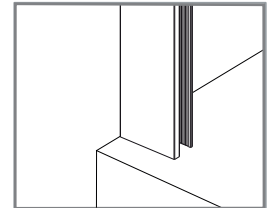
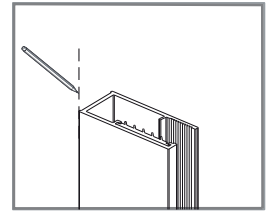
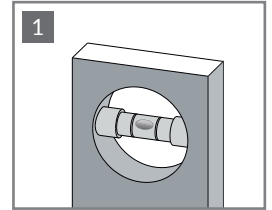
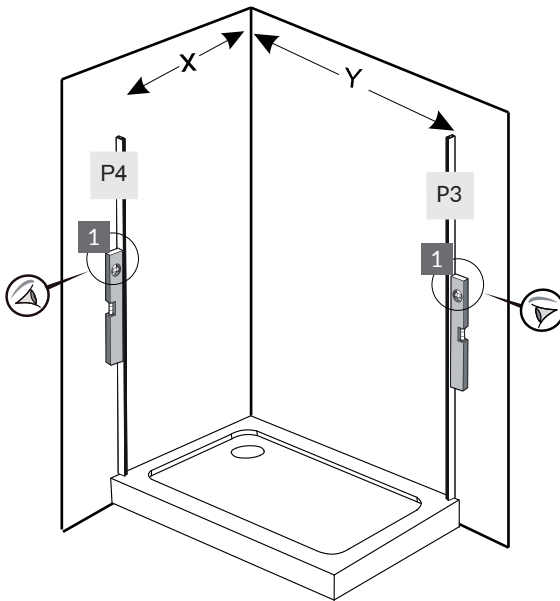

P4  x1

P3  x1



3.

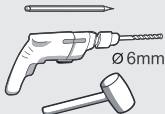
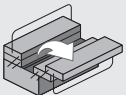
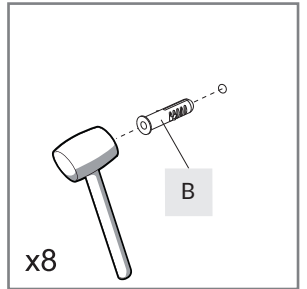
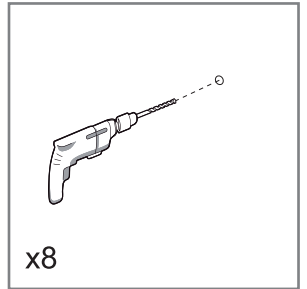
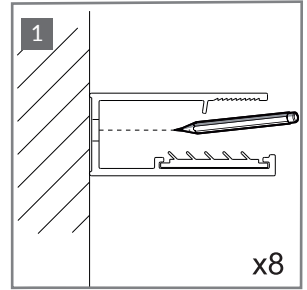
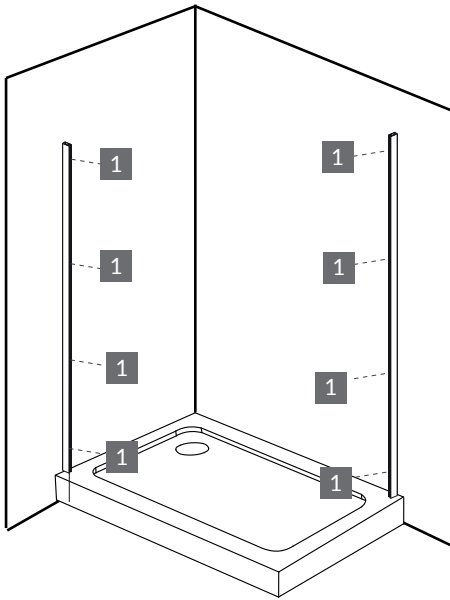
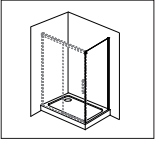

B



x8



4.

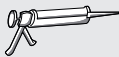
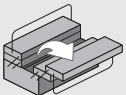
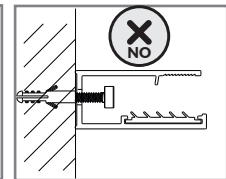
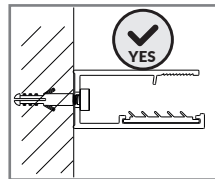
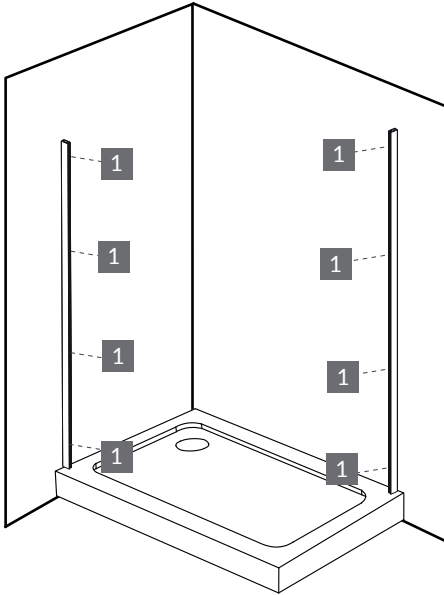
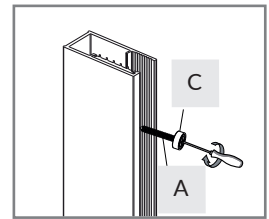
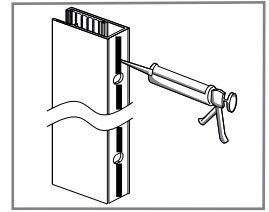
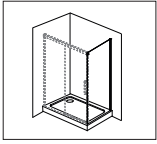

P4  x1

P3  x1

C  x8

A  x8
4x45



5.

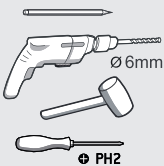
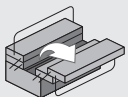
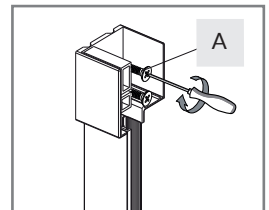
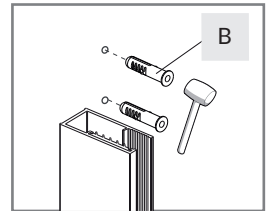
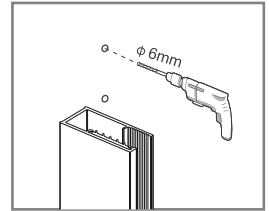
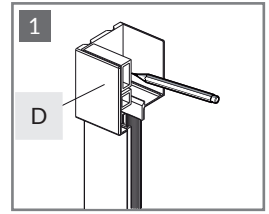
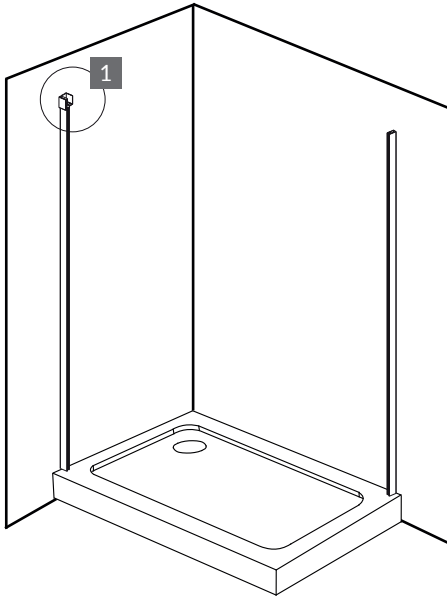
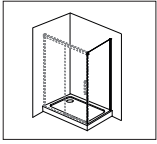

D



x1

B



x2

A



x2



6.

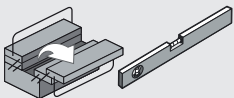
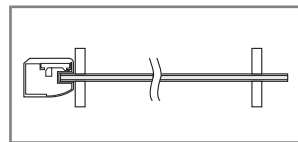
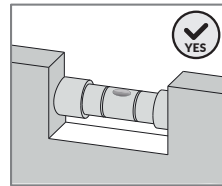
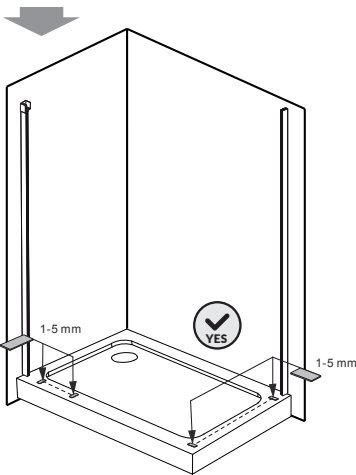
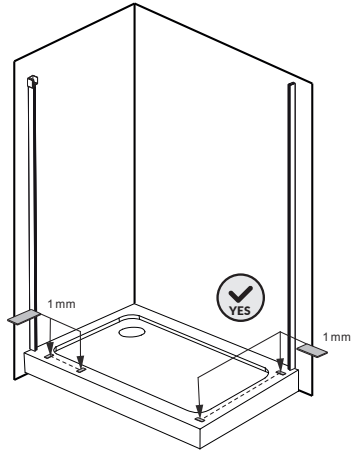
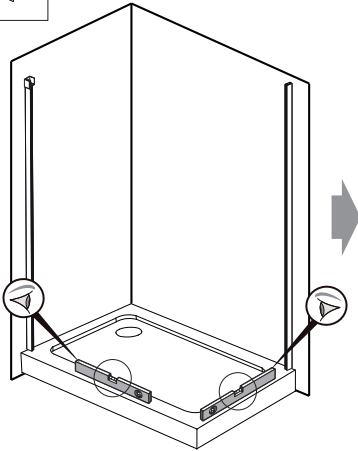
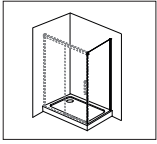

F1

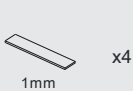

x4

F2

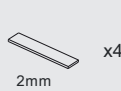

x4

F3



x4



7.

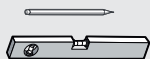
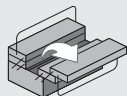
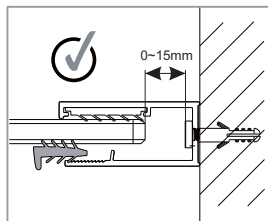
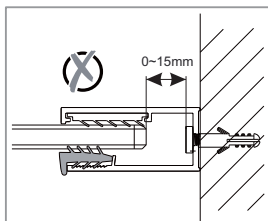
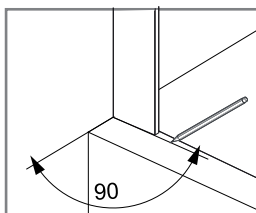
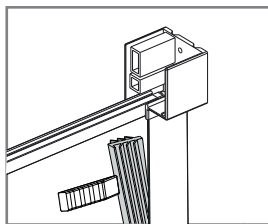
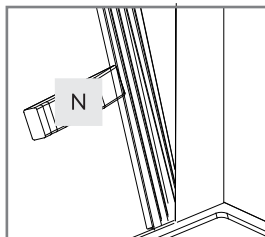
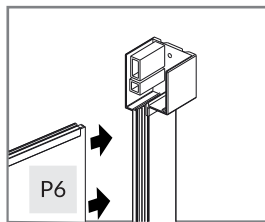
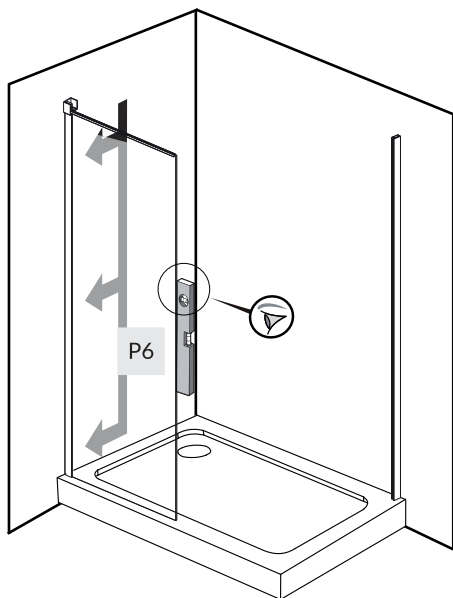
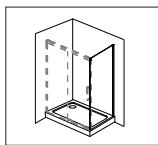

P5 ————— x1

N ————— x1



8.

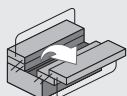
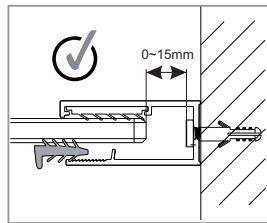
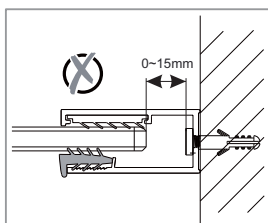
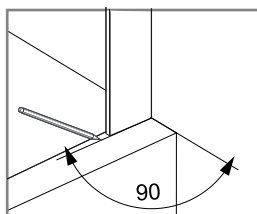
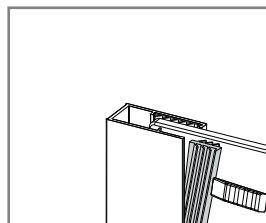
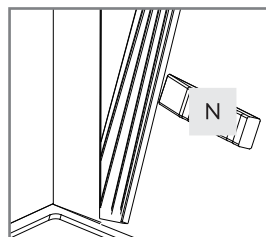
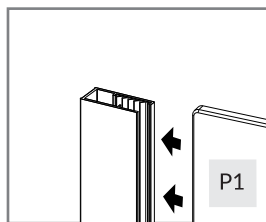
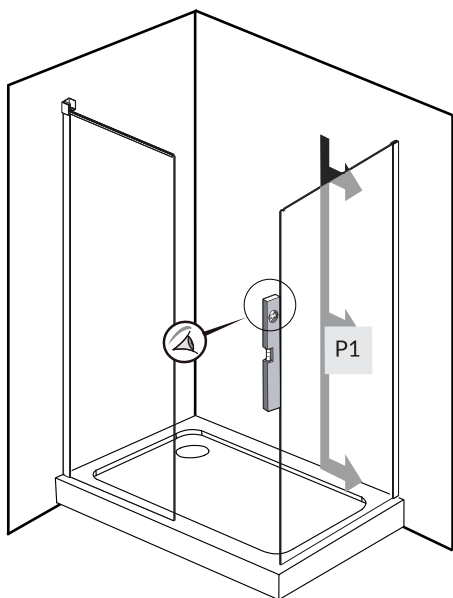
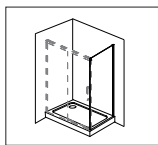

P5



x1

N



x1



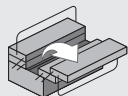
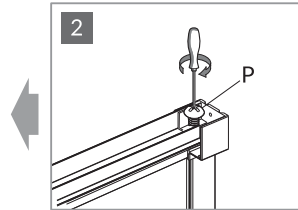
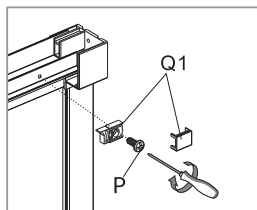
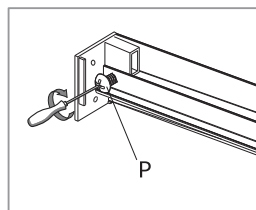
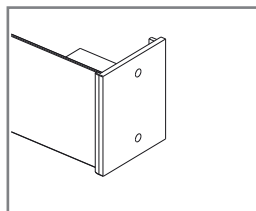
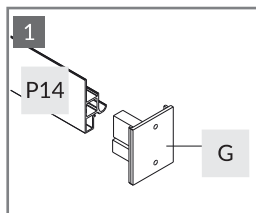
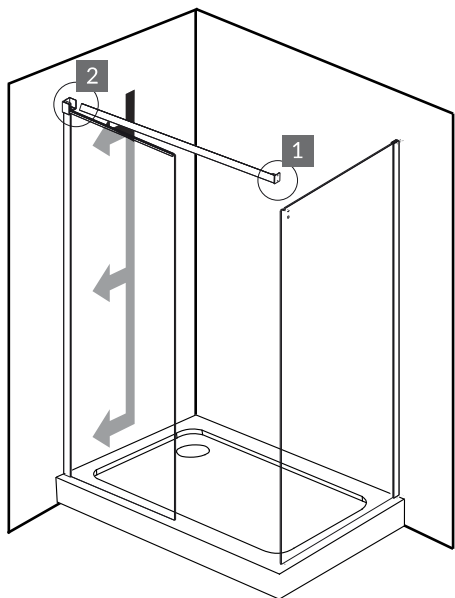
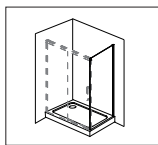

9.

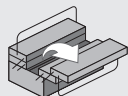
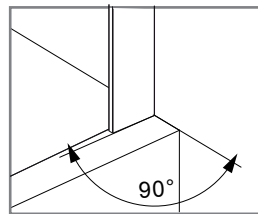
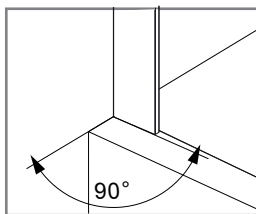
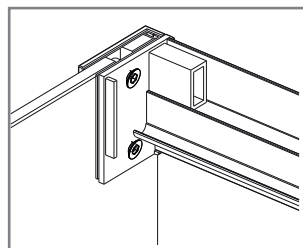
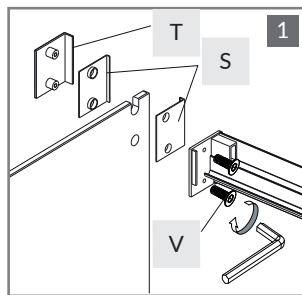
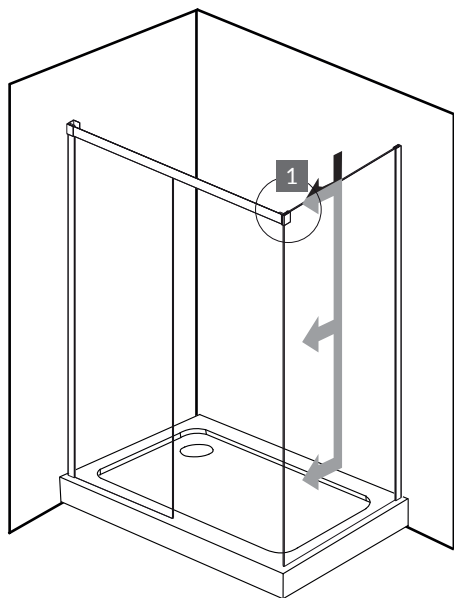
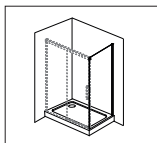

10.



- S  x2
- T  x1
- V  x2



x1



11.

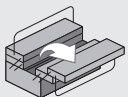
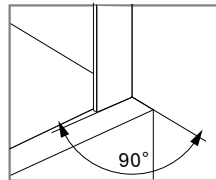
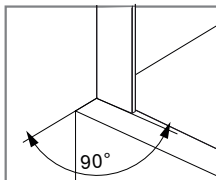
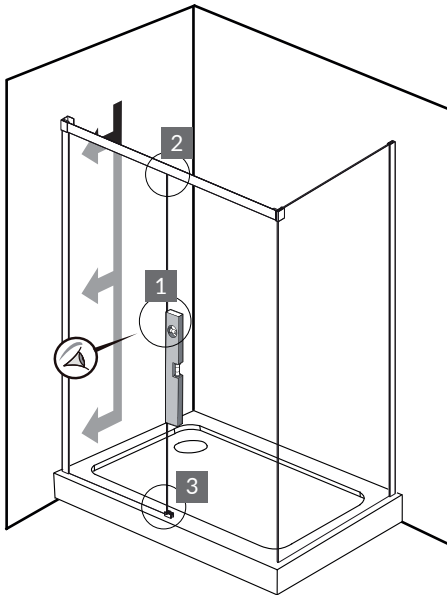
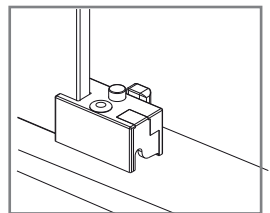
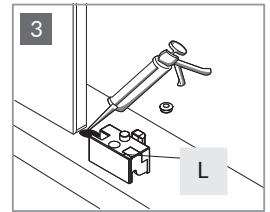
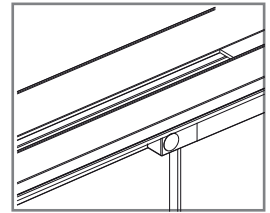
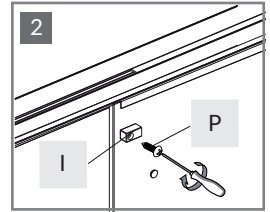
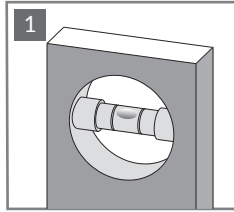
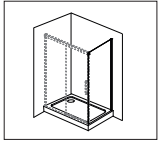

L



x1

I



x1

P



3.5x12 x1



12.

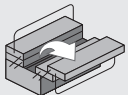
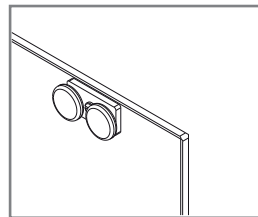
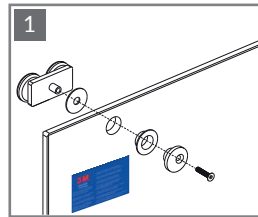
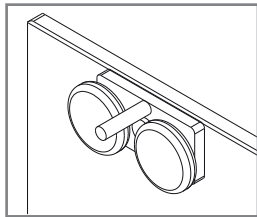
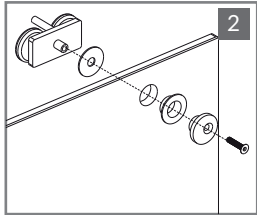
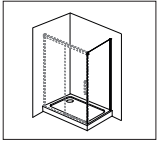



J  x1



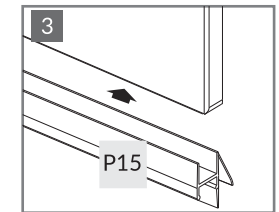
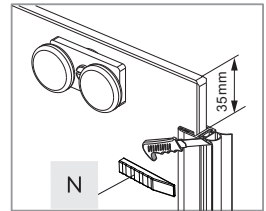
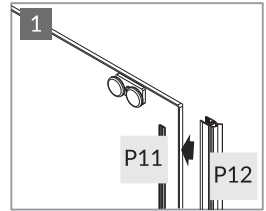
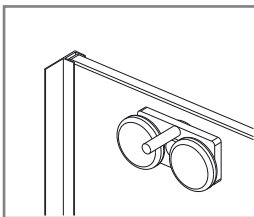
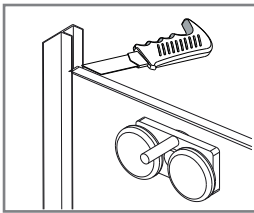
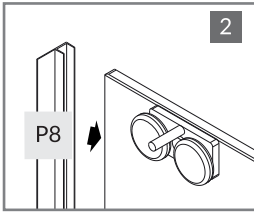
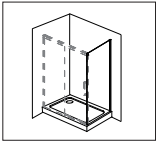

K  x1

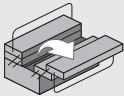

13.



P12		x1
P11		x1
P8		x1
P15		x1
N		x1

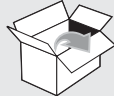

14.

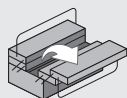
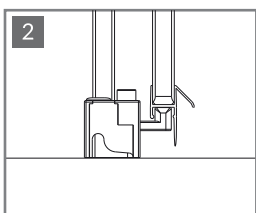
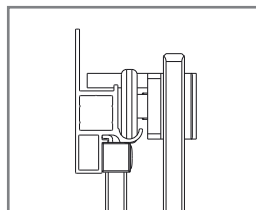
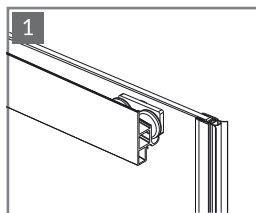
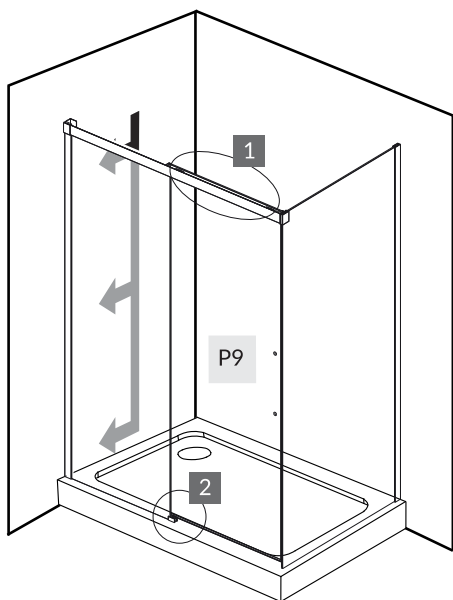
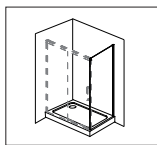

15.

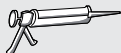
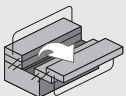
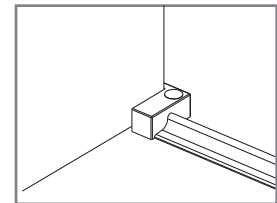
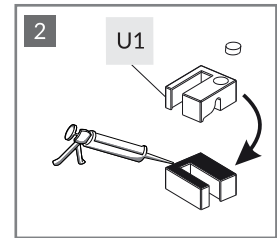
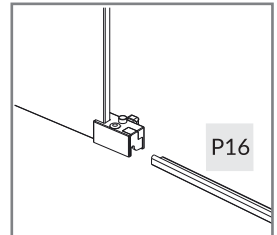
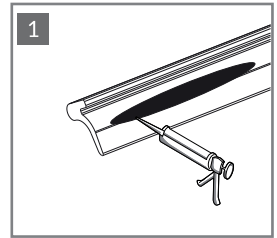
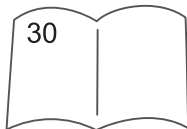
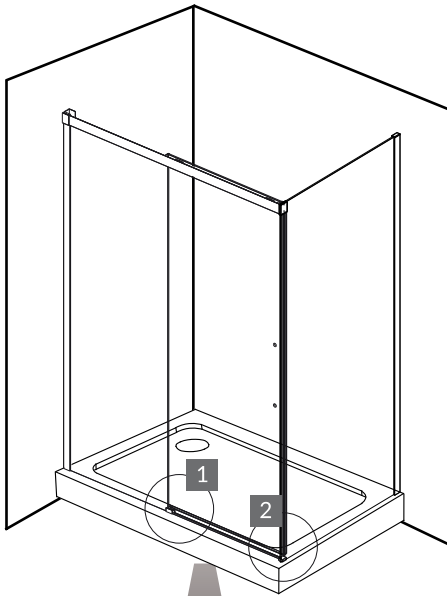
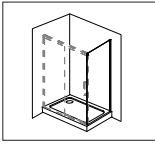

P16 ——— x1

U1  x1



16.

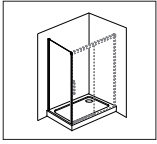

SIZE	X(mm)	Y(mm)
1200X800X2000	780-800	1180-1200
1200X900X2000	880-900	1180-1200
1400X800X2000	780-800	1380-1400
1400X900X2000	880-900	1380-1400

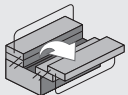
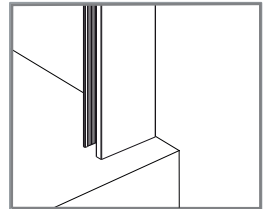
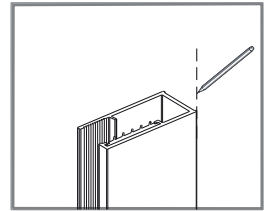
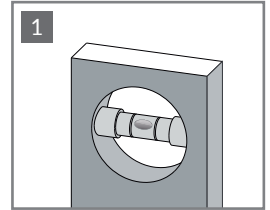
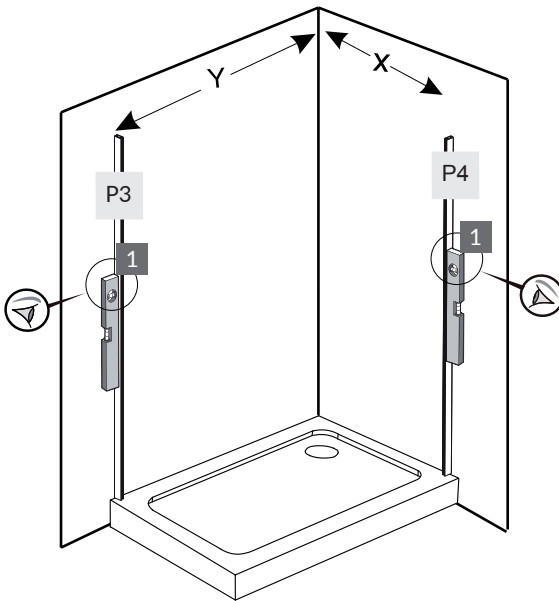

P4  x1

P3  x1



17.

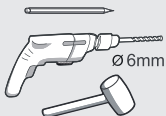
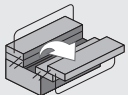
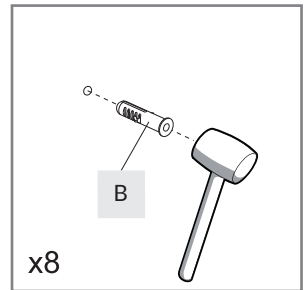
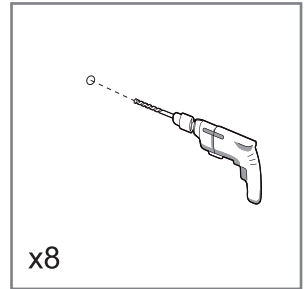
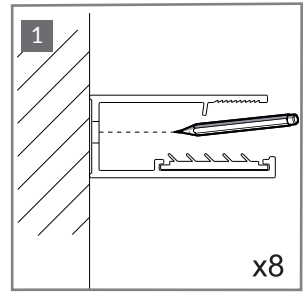
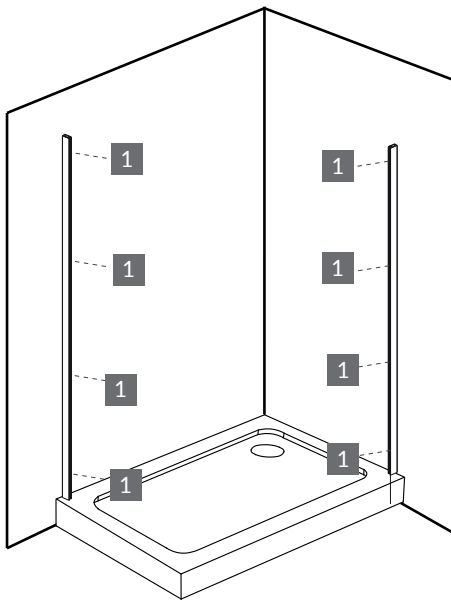
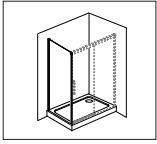

B



x8



18.

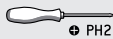
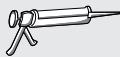
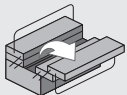
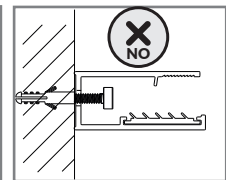
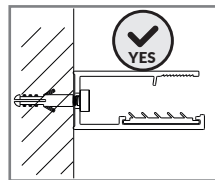
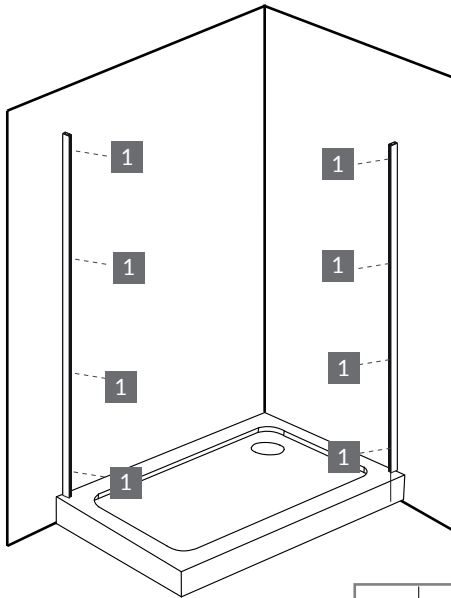
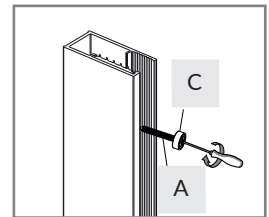
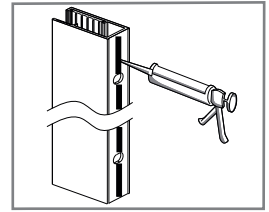
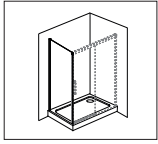

P4



x1

P3



x1

C

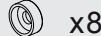

x8

A



x8



19.

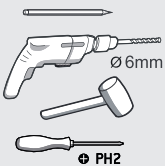
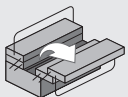
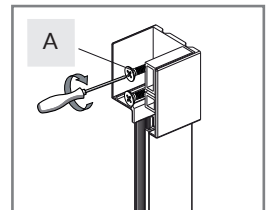
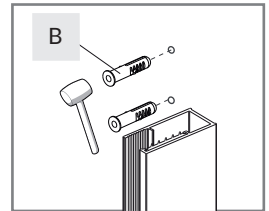
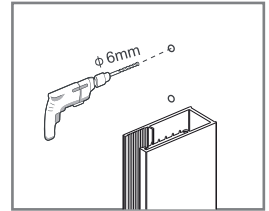
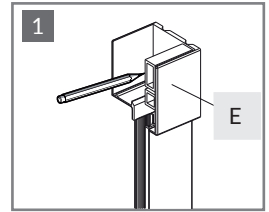
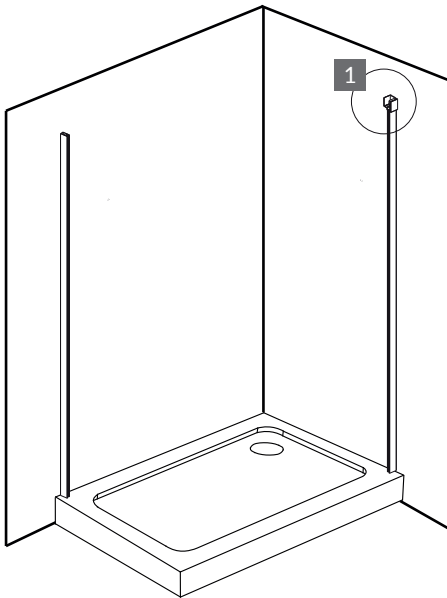
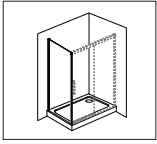

E



x1

B



x2

A



x2



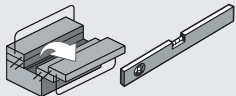
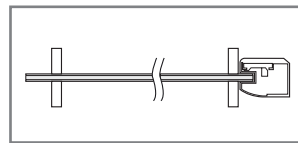
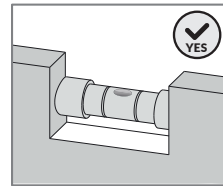
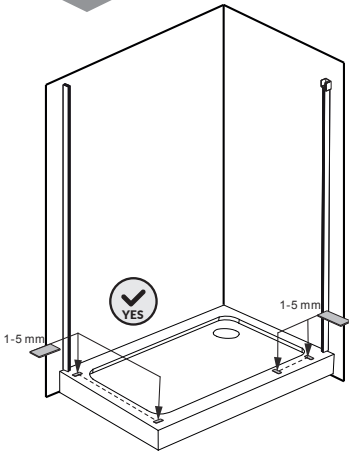
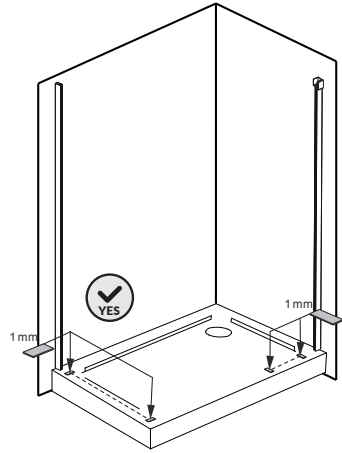
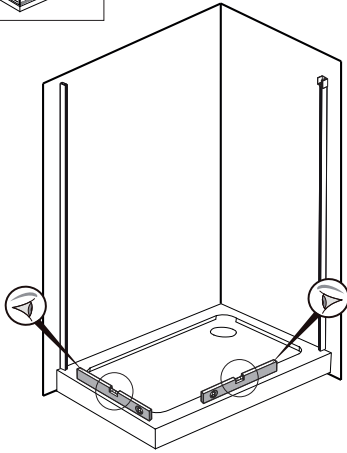
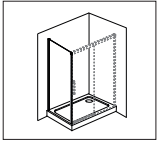

F1



x4

F2



x4

F3



x4



21.

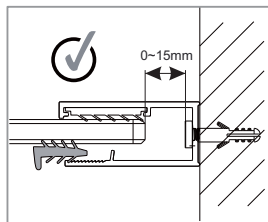
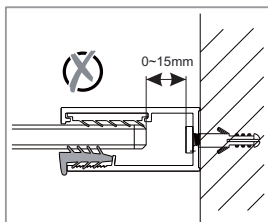
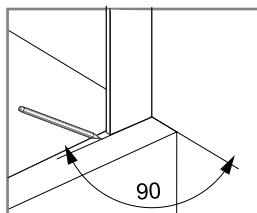
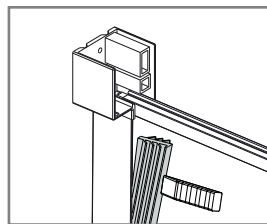
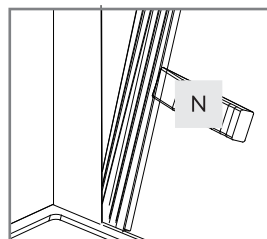
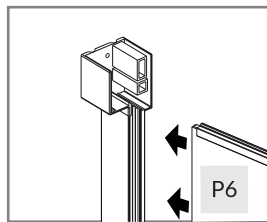
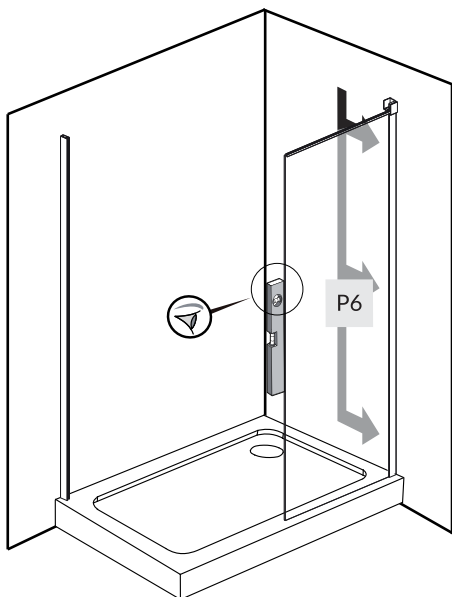
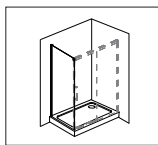

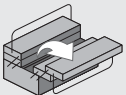
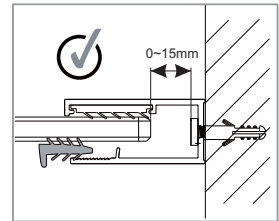
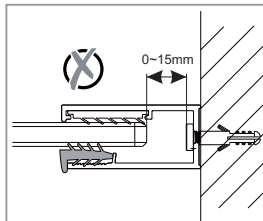
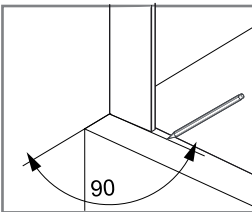
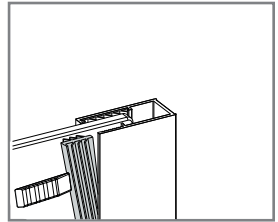
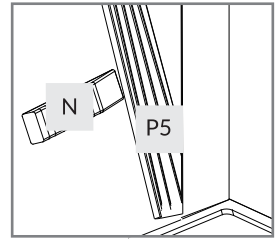
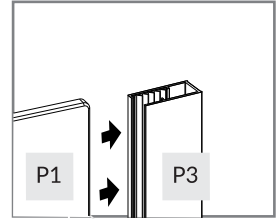
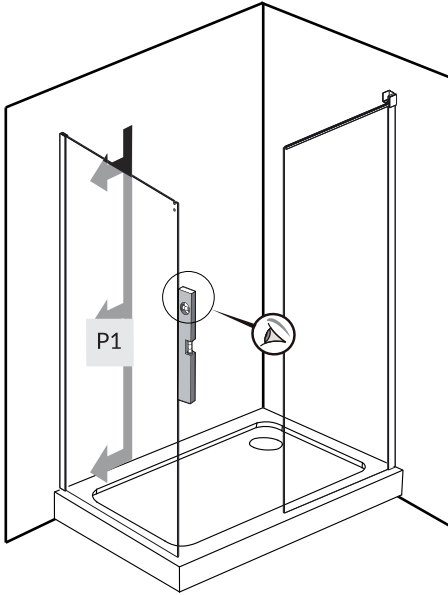
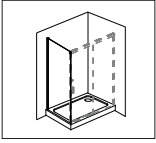

P5



x1

N



x1



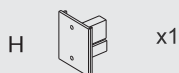
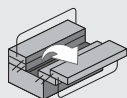
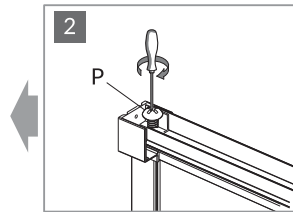
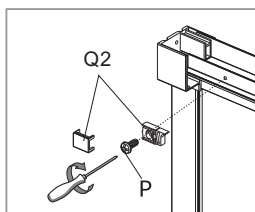
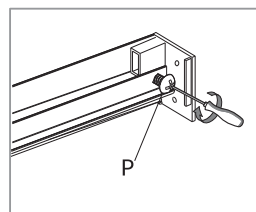
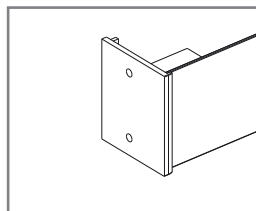
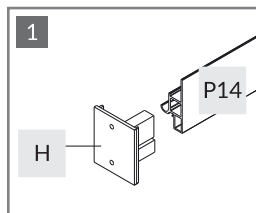
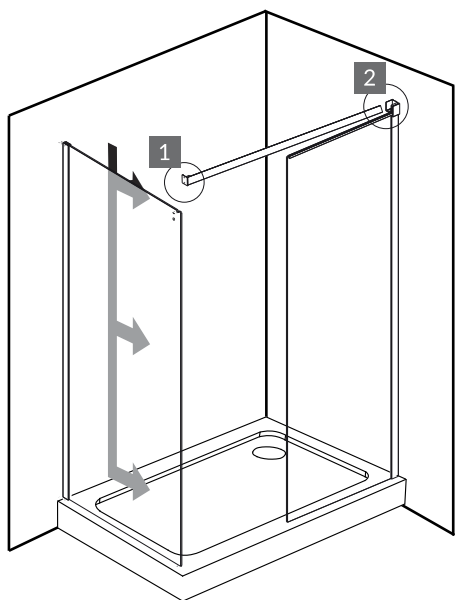
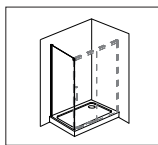

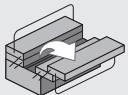
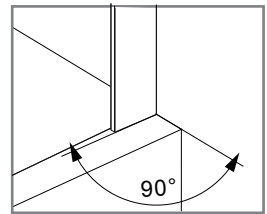
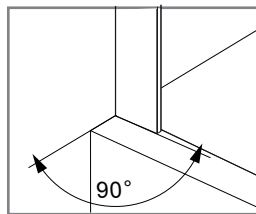
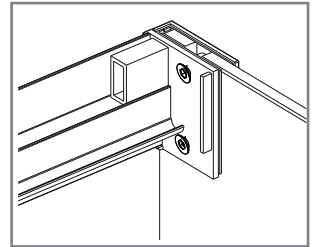
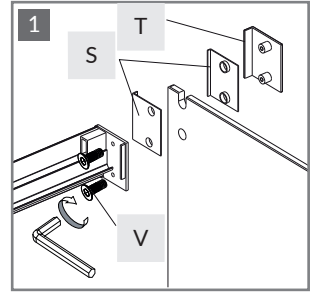
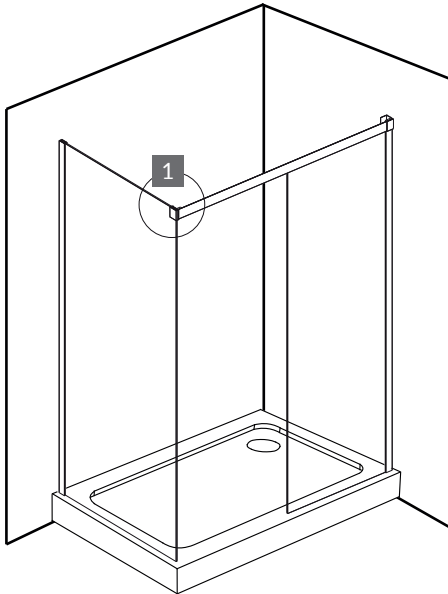
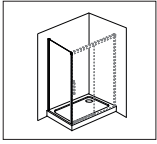

PH2

S  x2

T  x1

V  x2

 x1



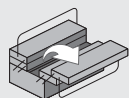
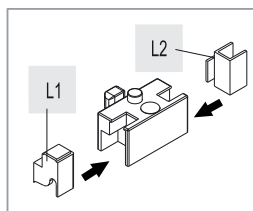
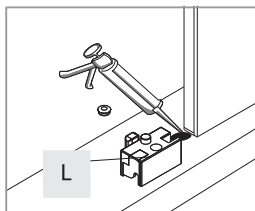
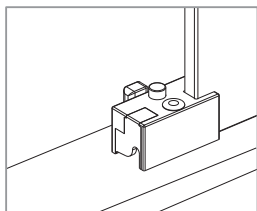
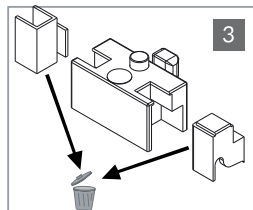
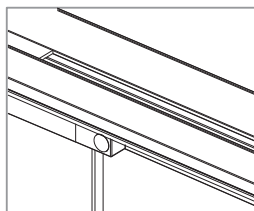
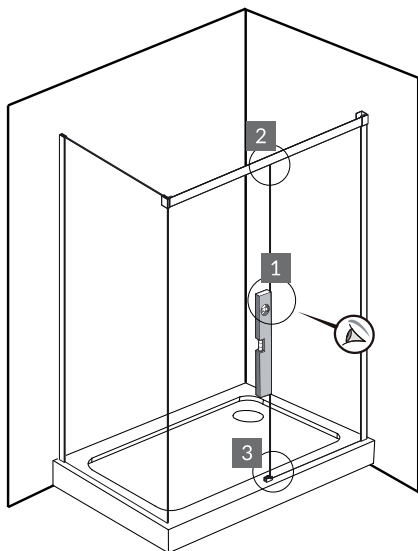
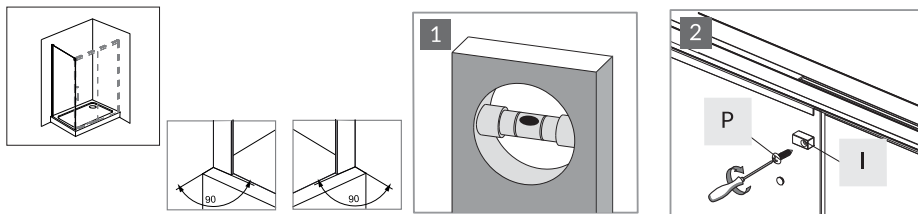

L x1



I x1



L1



L2



P



3.5x12 x1



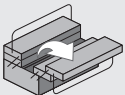
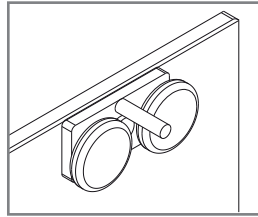
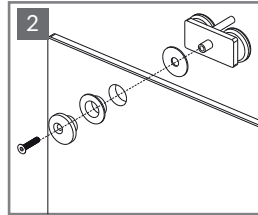
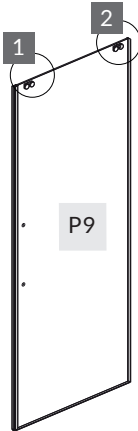
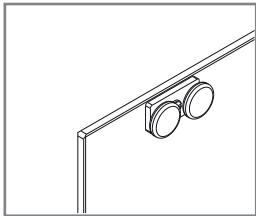
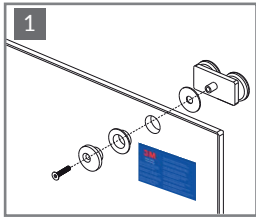
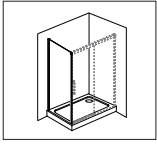

J



x1

K



x1



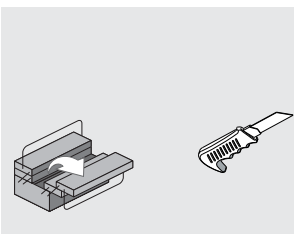
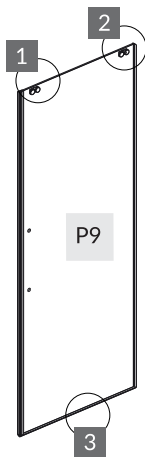
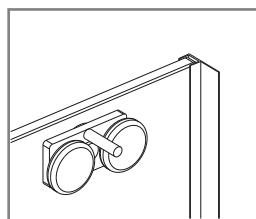
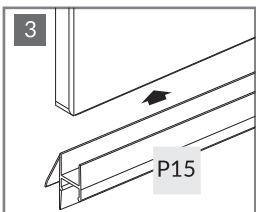
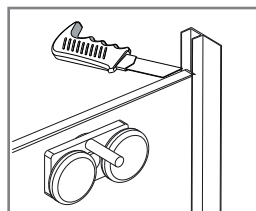
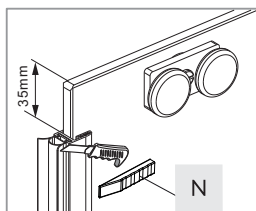
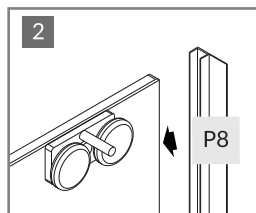
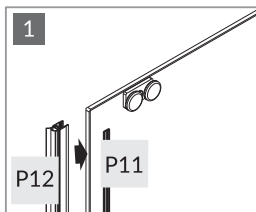
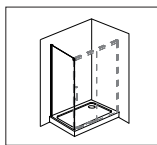

- P12 x1
- P11 x1
- P8 x1
- P15 x1
- N x1



28.

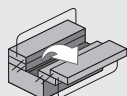
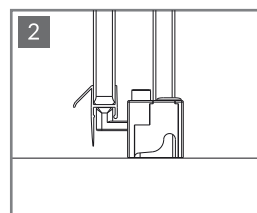
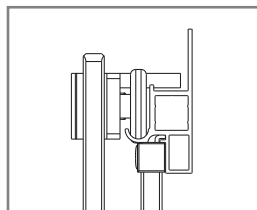
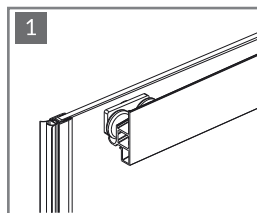
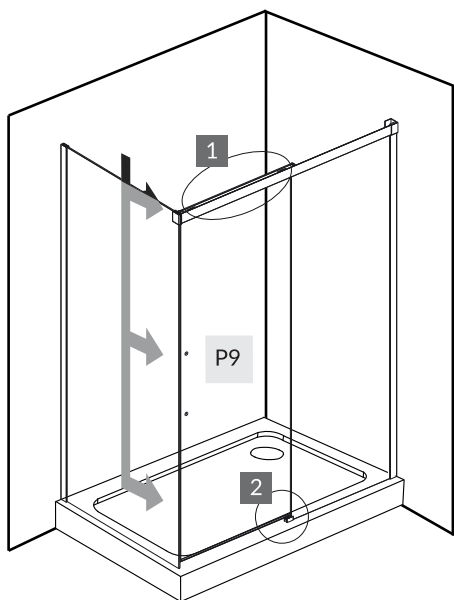
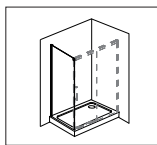

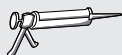
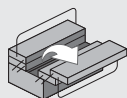
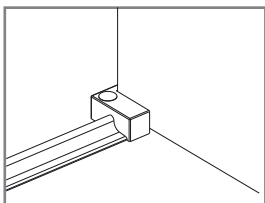
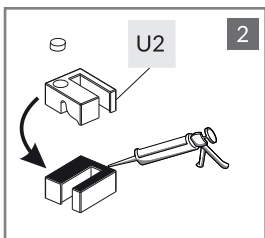
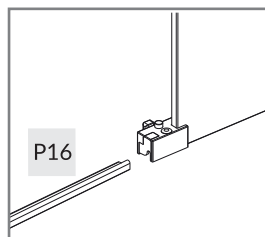
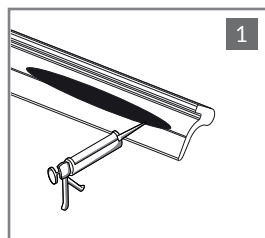
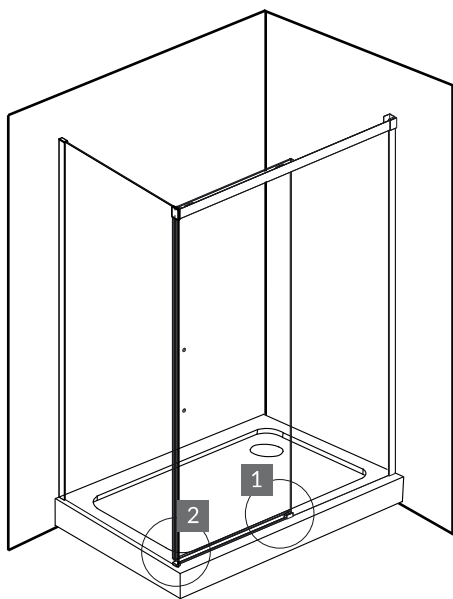
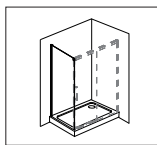

P16 ————— x1

U2  x1



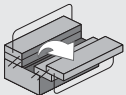
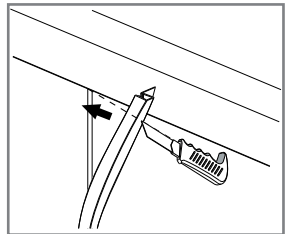
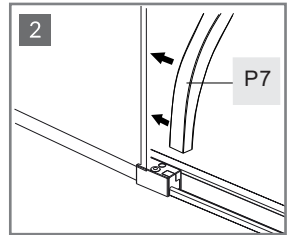
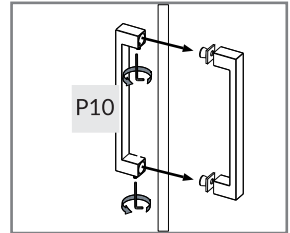
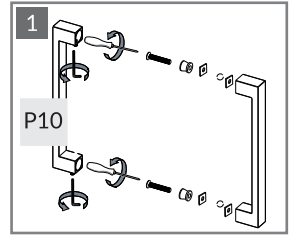
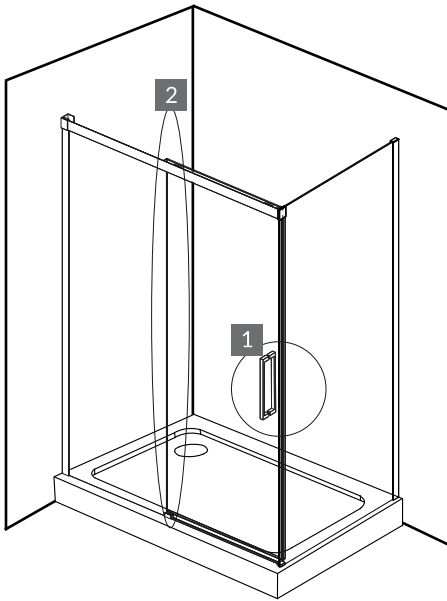

P7



x1

P10

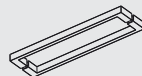

x1



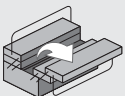
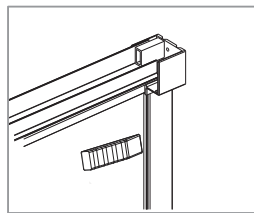
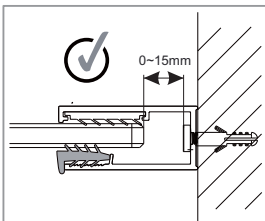
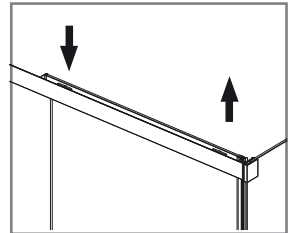
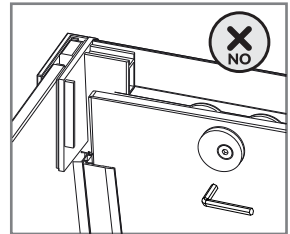
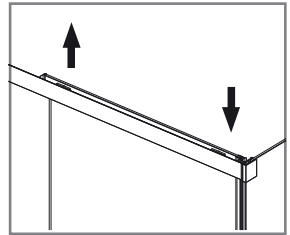
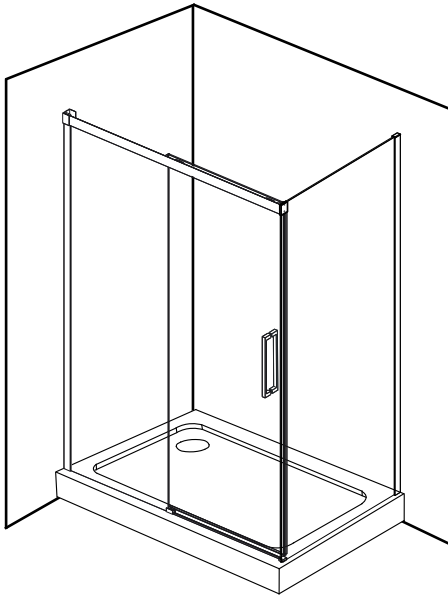
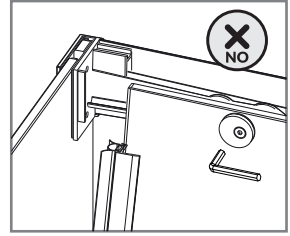
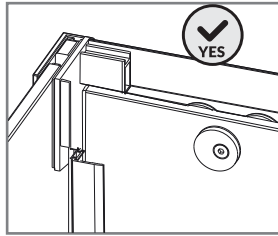

R 

x1

N 

x1



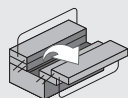
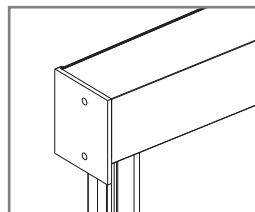
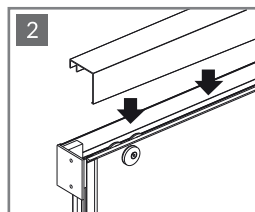
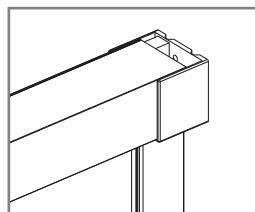
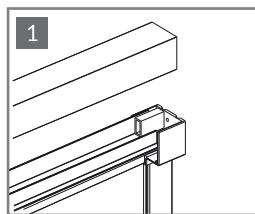
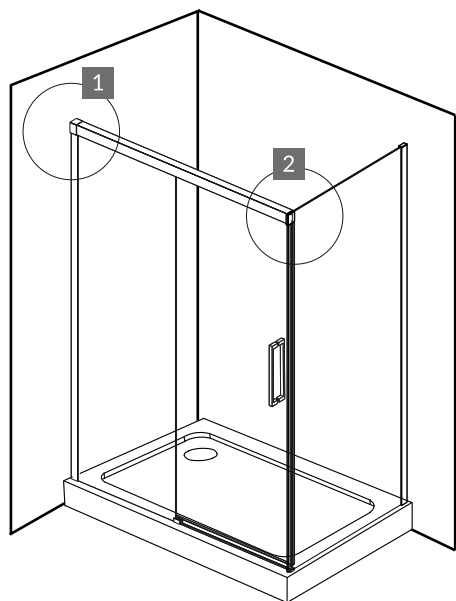

P13



x1



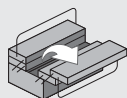
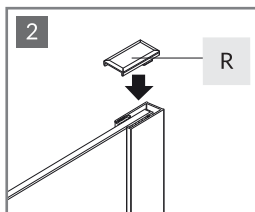
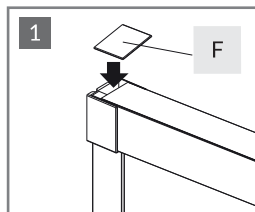
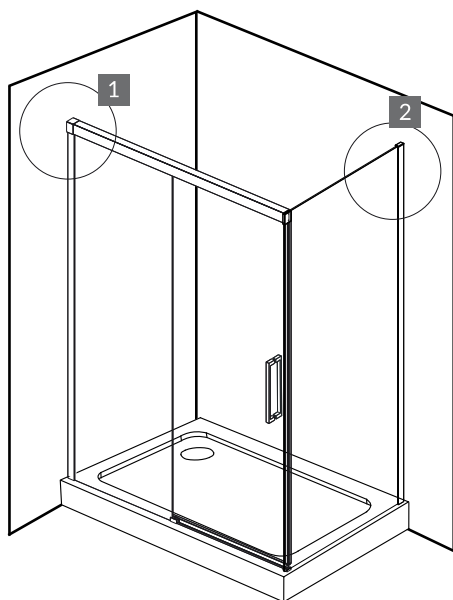

R  x1

F  x1



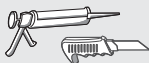
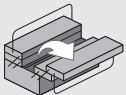
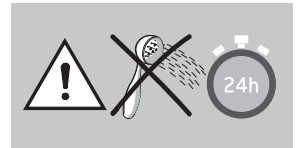
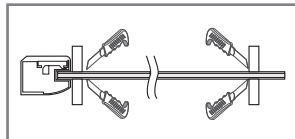
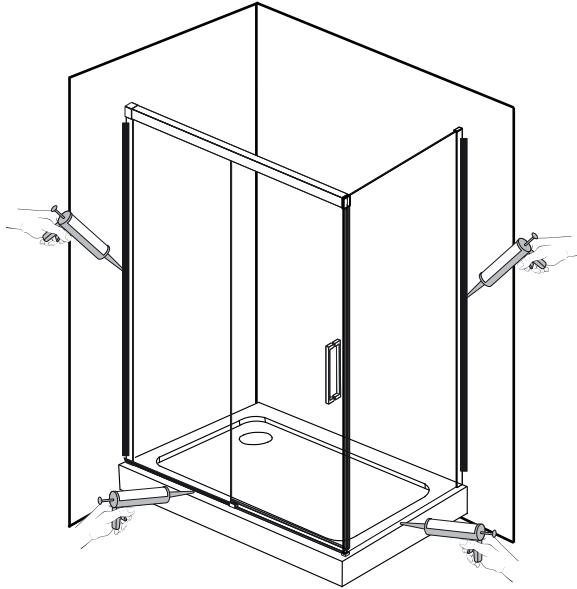



6.5 < PH < 7.5

