

Moduo

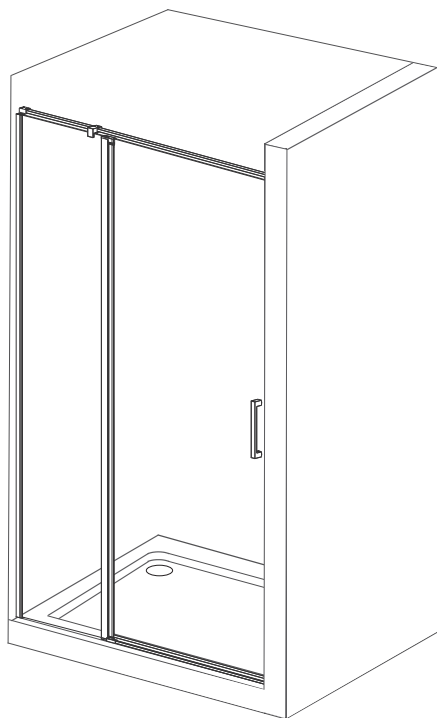

PL INSTRUKCJA MONTAŻU I EKSPLOATACJI

CZ NÁVOD NA MONTÁŽ A ÚDRŽBU

SK NÁVOD NA MONTÁŽ A ÚDRŽBU

EST PAIGALDUS- JA KASUTUSJUHEND

LT MONTAVIMO IR EKSPLOATAVIMO INSTRUKCIJA

LV MONTĀŽAS UN EKSPLUATĀCIJAS INSTRUKCIJA

DE MONTAGE- UND AUFBAUANLEITUNG

RO INSTRUCȚIUNI DE MONTAJ ȘI OPERARE

HU SZERELÉSI ÉS ÜZEMELTETÉSI ÚTMUTATÓ

UA ІНСТРУКЦІЯ З МОНТАЖУ І ЕКСПЛУАТАЦІЇ

BY ІНСТРУКЦЫЯ ПА МАНТАЖЫ І ЭКСПЛУАТАЦЫІ

RU ИНСТРУКЦИЯ ПО МОНТАЖУ И ЭКСПЛУАТАЦИИ





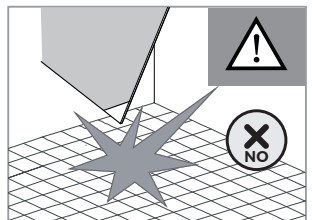
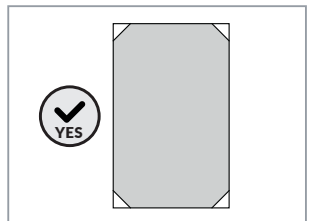
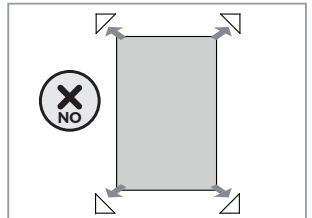
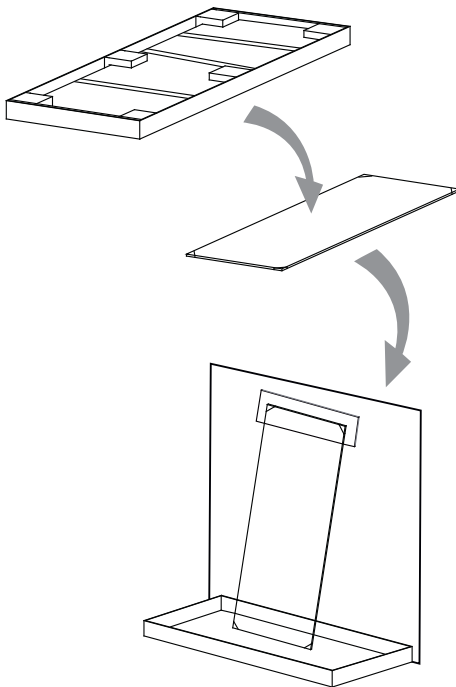
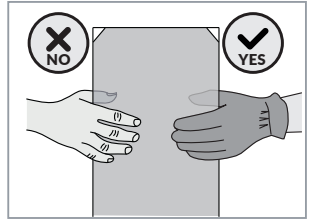
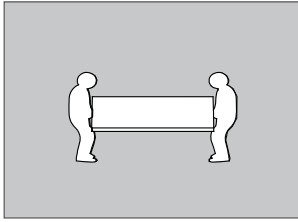
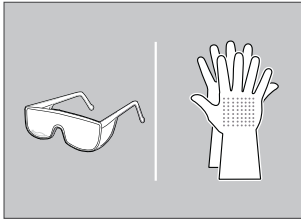
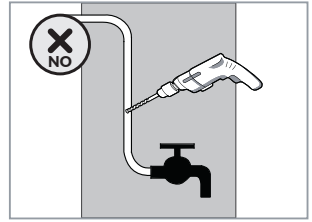
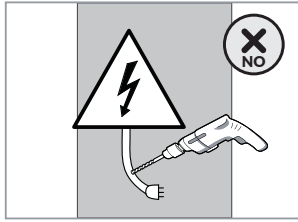
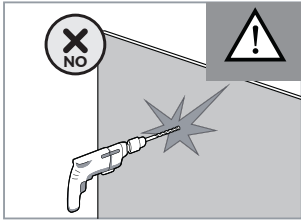

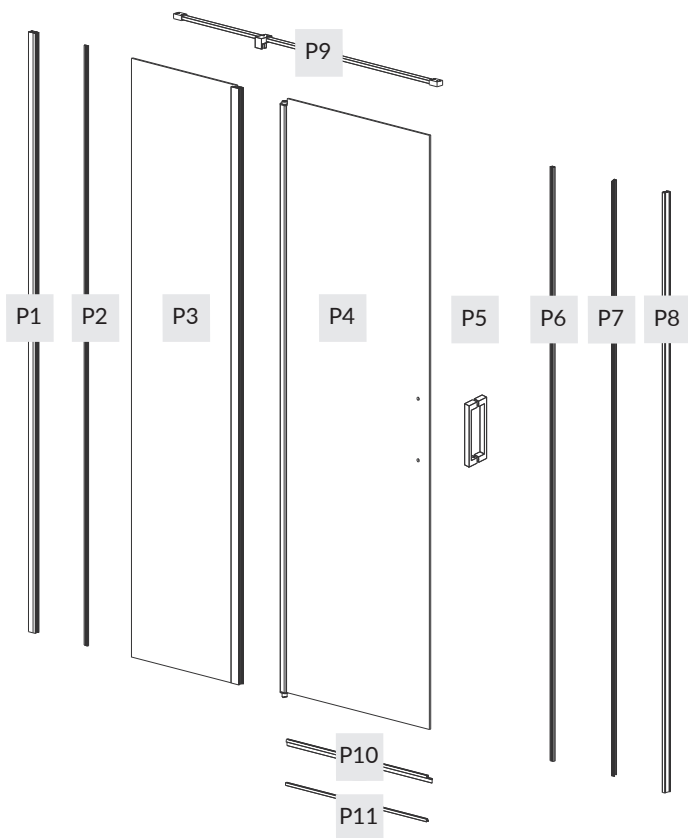









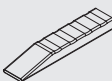

EN INSTRUCTIONS FOR ASSEMBLY AND USE

FR INSTALLATION ET UTILISATION - MODE







- | | | | | | | | |
|----|--|----|--|----|--|----|--|
| A |  x8 | B |  x8 | C |  x2 | D |  x4 |
| | 4X35 | | | | | | |
| E |  x2 | F1 |  x4 | F2 |  x4 | F3 |  x4 |
| | 3.5X20 | | 1mm | | 2mm | | 3mm |
| G1 |  x1 | G2 |  x1 | H |  x1 | I1 |  x1 |
| I2 |  x1 | K |  x1 | M1 |  x1 | M2 |  x1 |
| N2 |  x2 | P |  x4 | | | | |

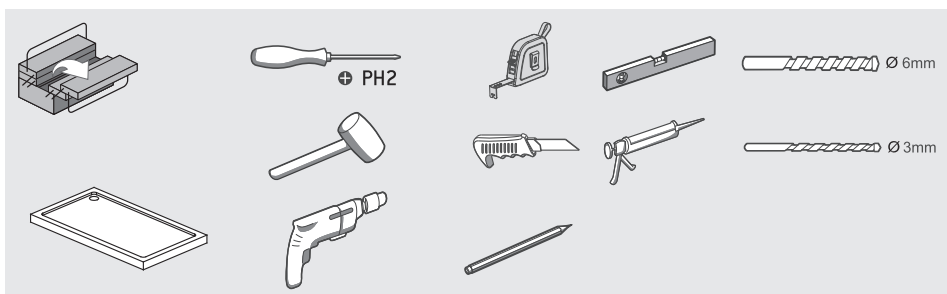

1.

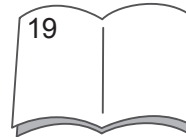
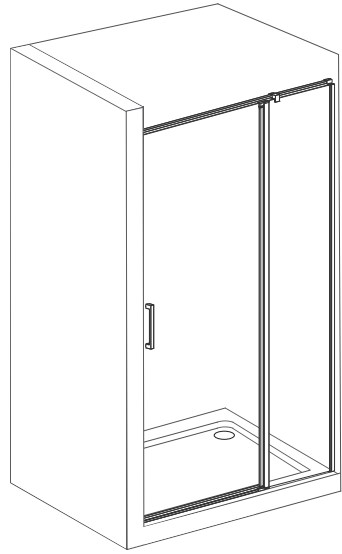
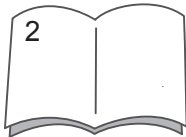
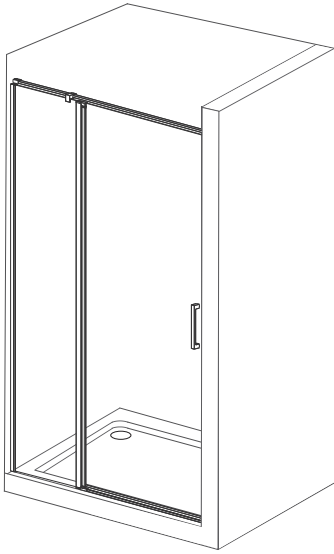

2.

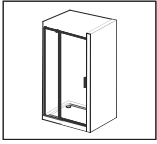

SIZE	X(mm)
800×1950	790-800
900×1950	890-900
1000×1950	990-1000

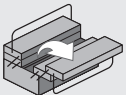
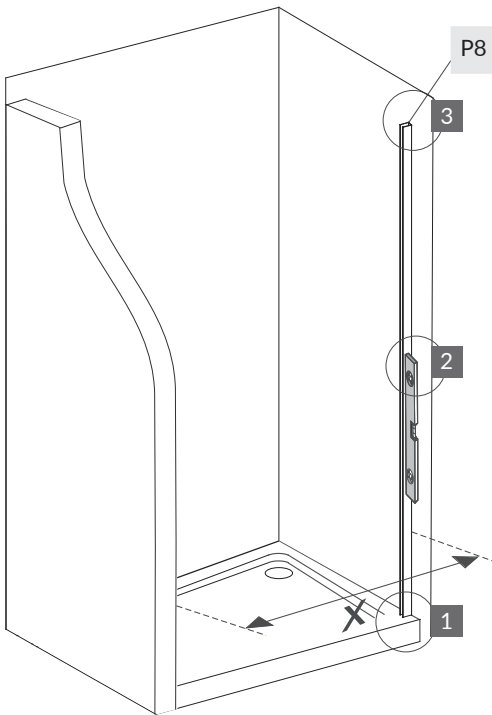
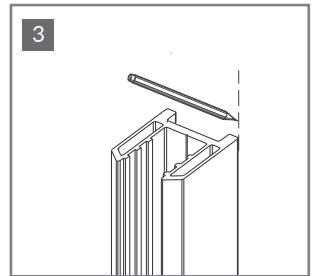
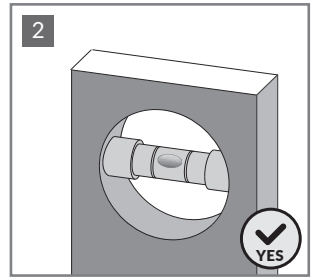
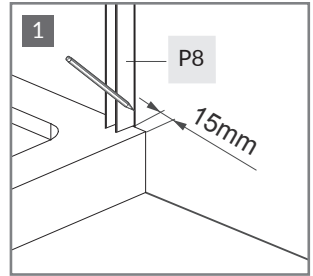

P8



3.

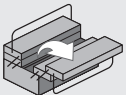
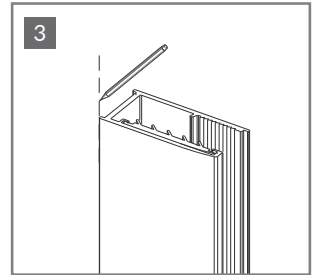
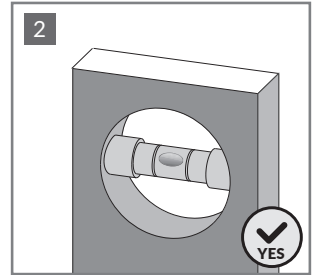
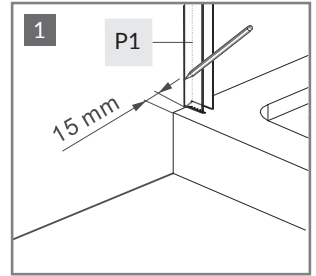
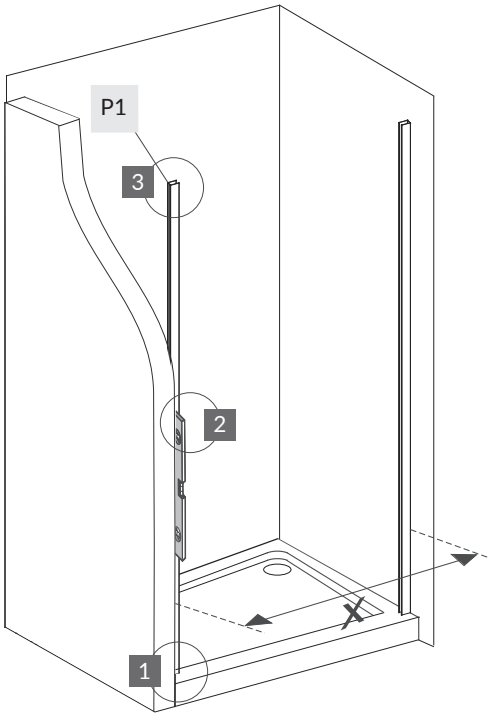
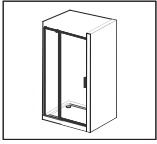

P1

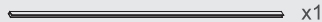

x1



4.

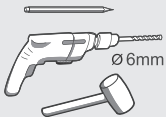
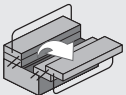
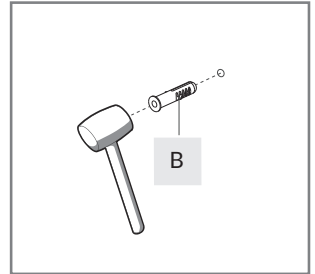
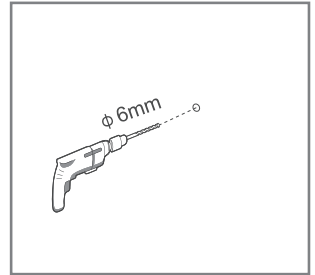
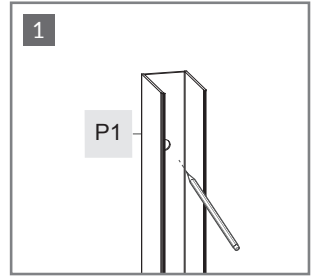
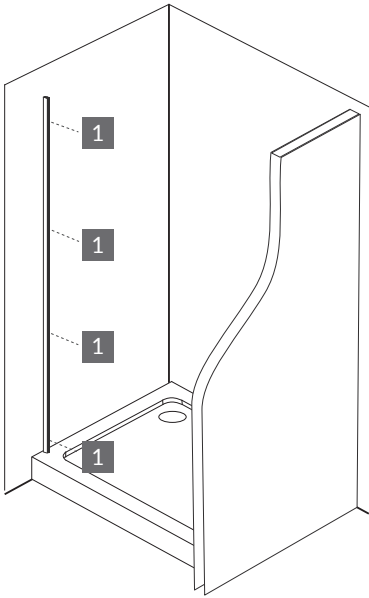
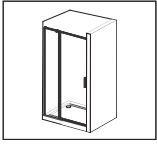

B



x4

P1



x1



5.

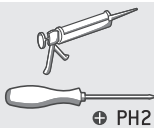
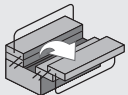
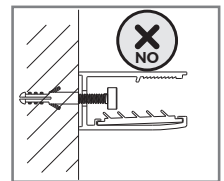
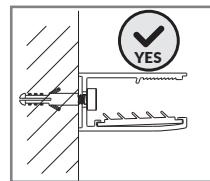
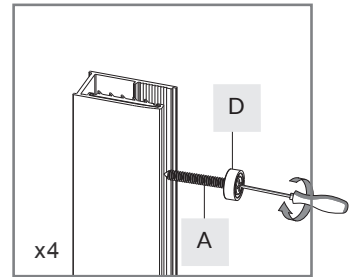
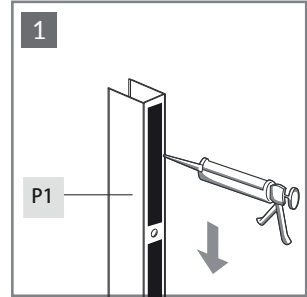
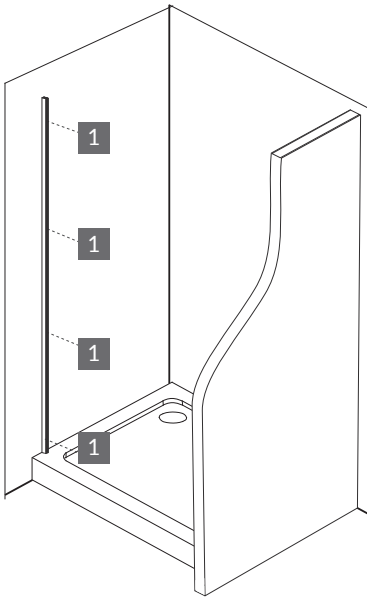
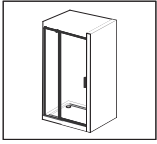

A

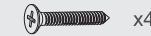

x4

D



x4

P1

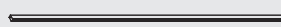

x1



6.

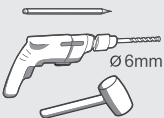
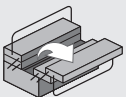
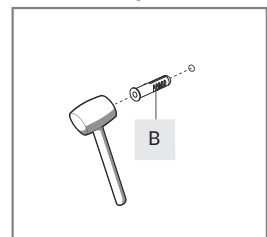
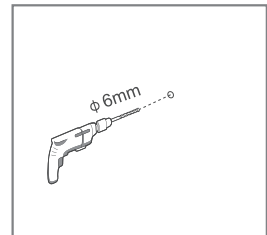
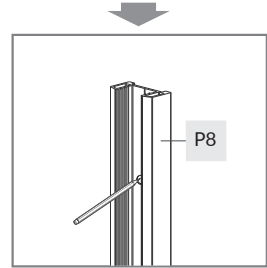
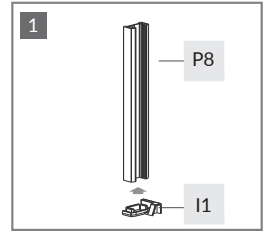
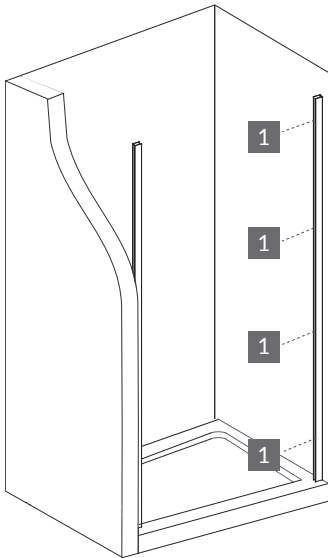
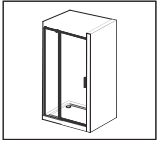

B



x4

I1



x1

P8



x1



7.

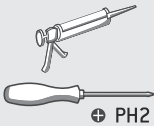
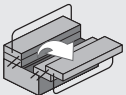
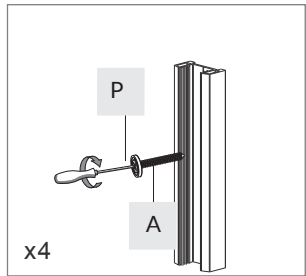
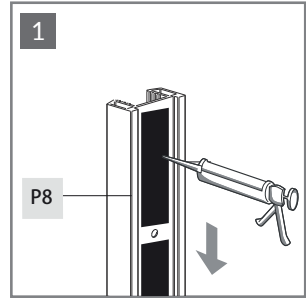
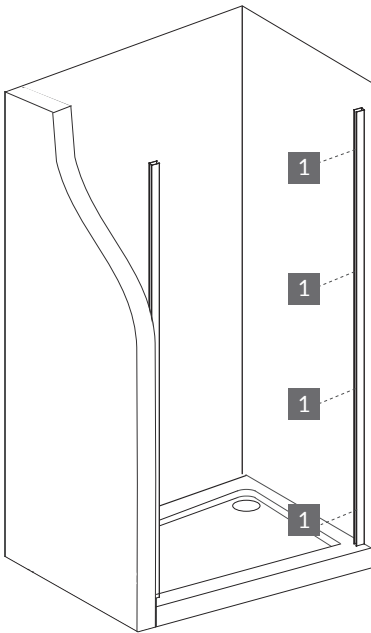
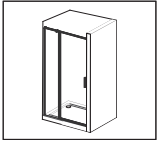

A
P
P8



x4

x4



x1



8.

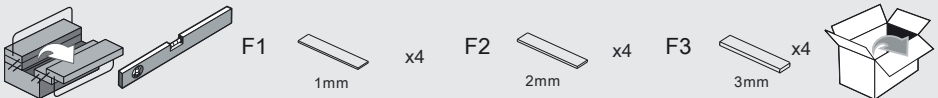
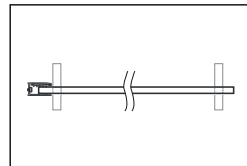
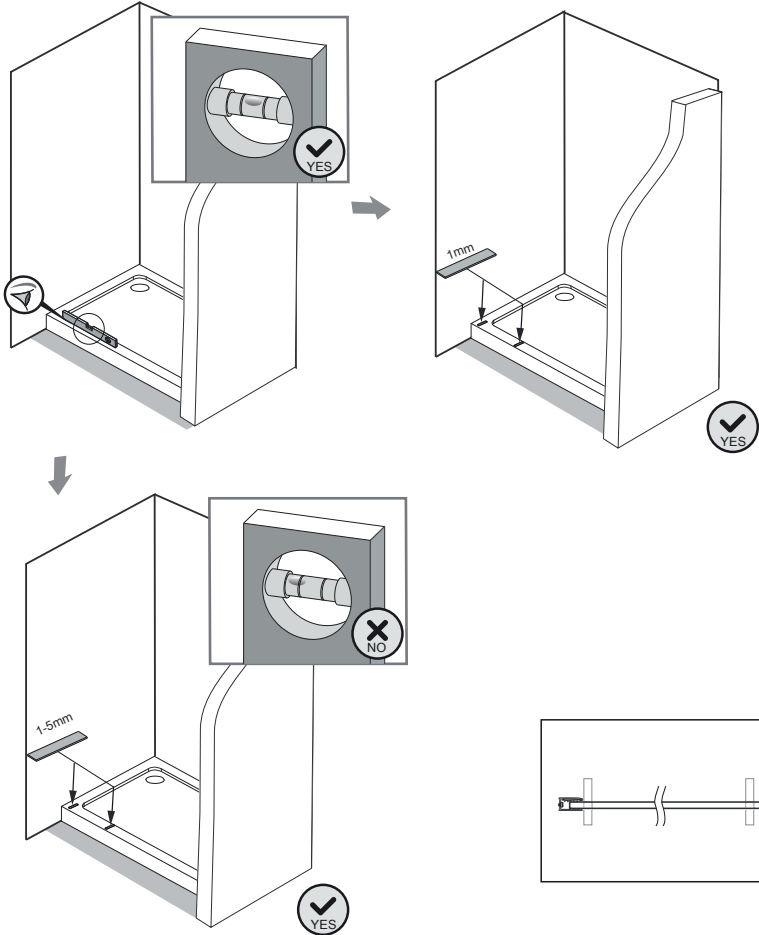
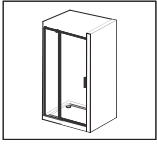

9.

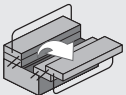
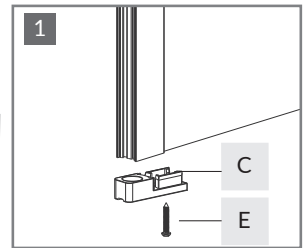
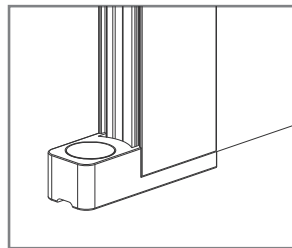
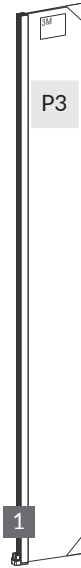
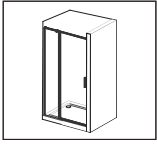

C

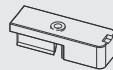

x1

E



x1



10.

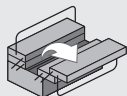
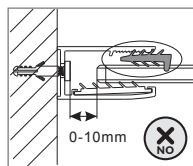
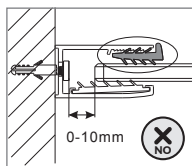
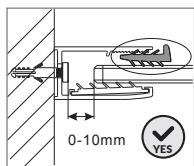
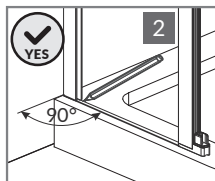
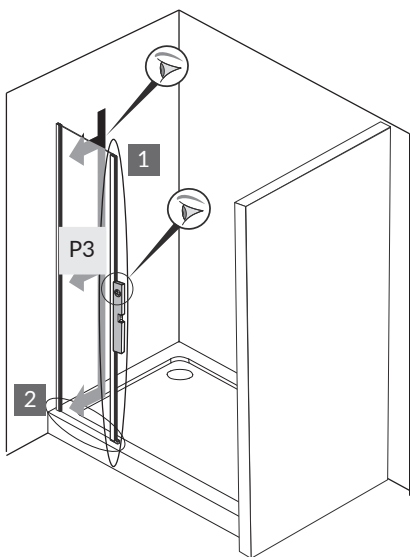
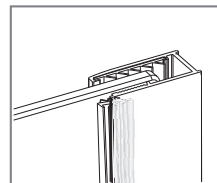
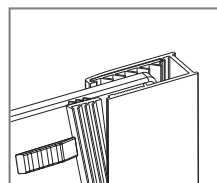
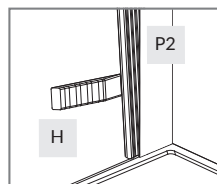
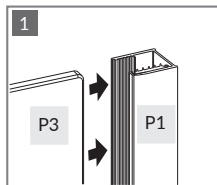
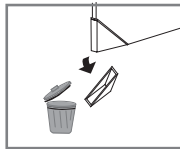
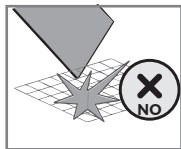
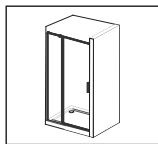

P2

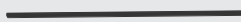

x1

H



x1



11.

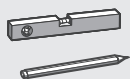
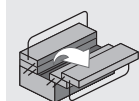
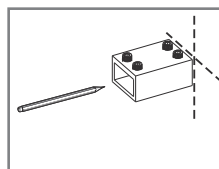
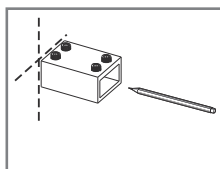
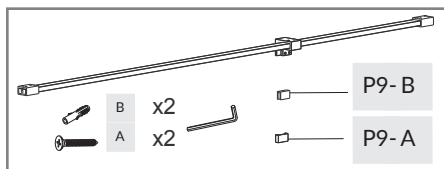
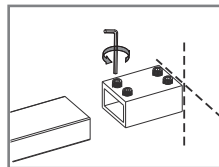
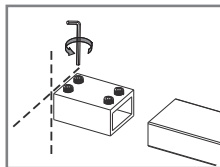
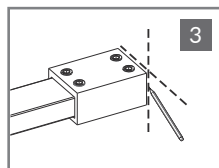
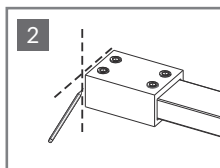
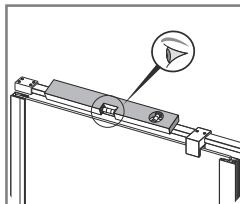
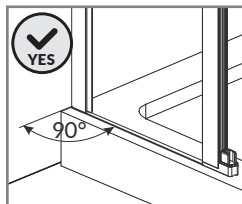
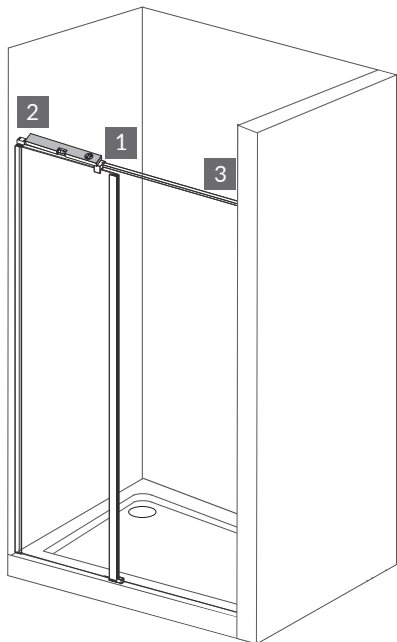
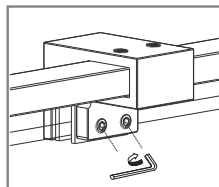
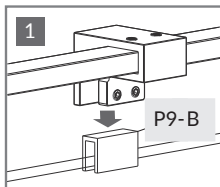
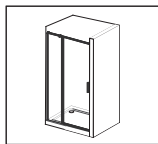

P9



x1



12.

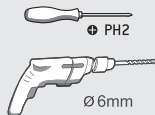
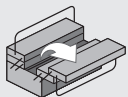
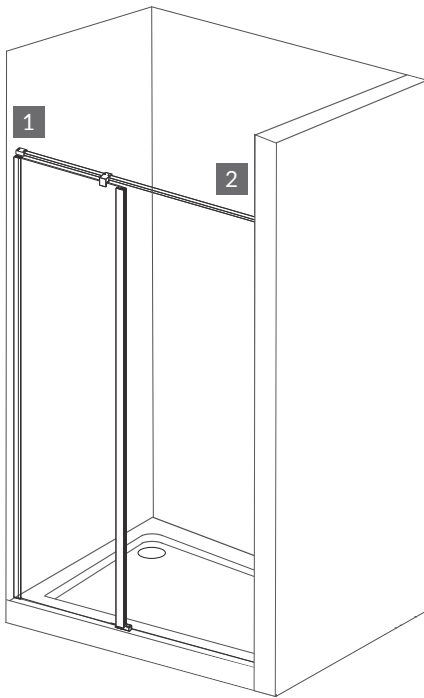
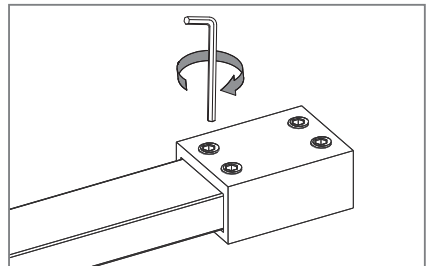
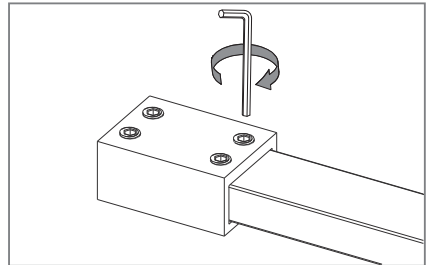
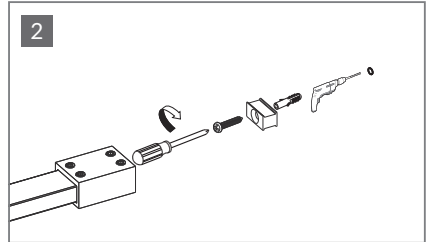
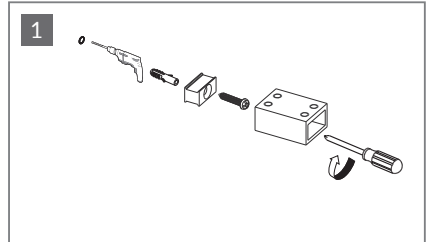
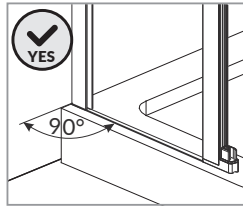
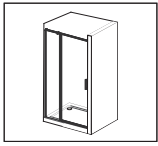

P9



x1

B



x2

A



x2



13.

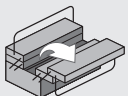
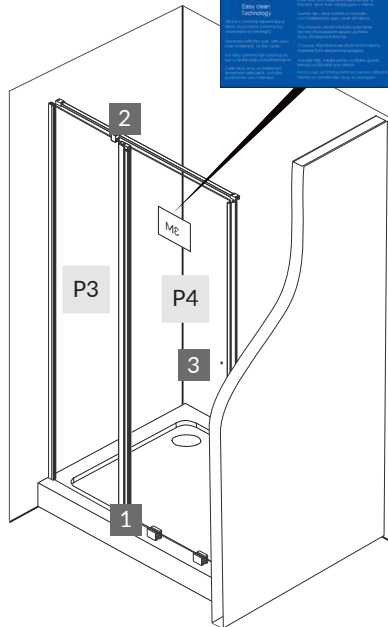
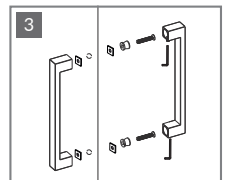
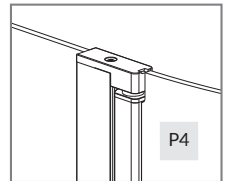
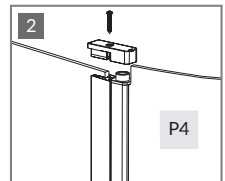
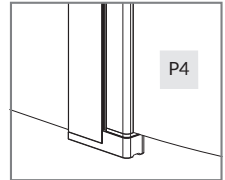
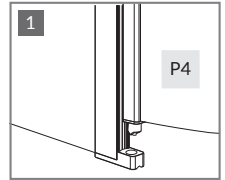
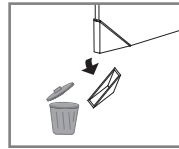
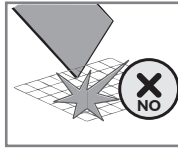
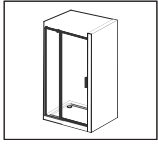

N2



x2 C

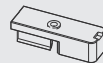

x1

P5



x1 E



x1



14.

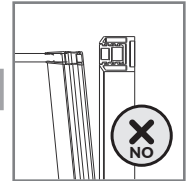
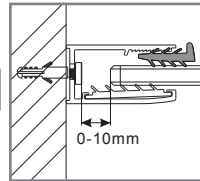
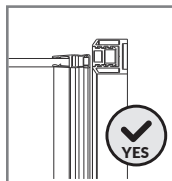
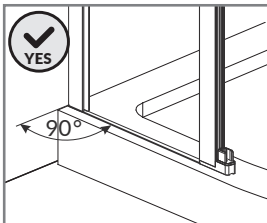
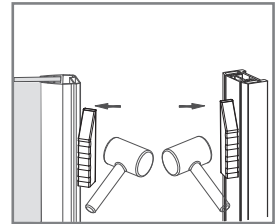
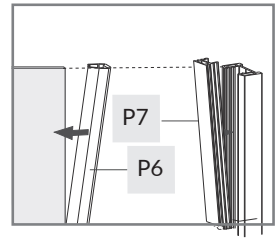
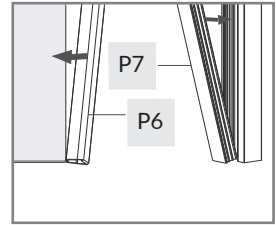
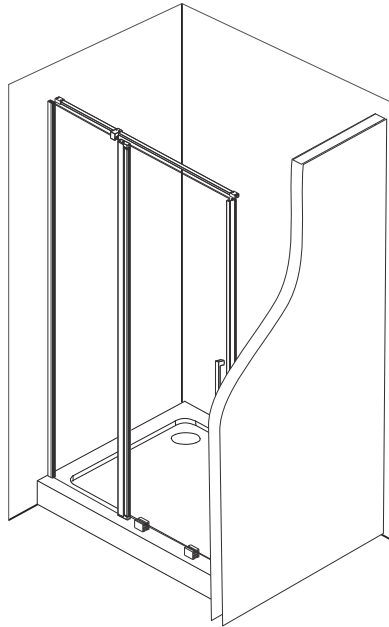
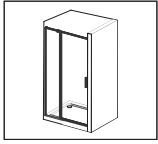

		P6		x1	
		P7		x1	
		H		x1	

15.

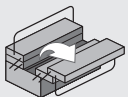
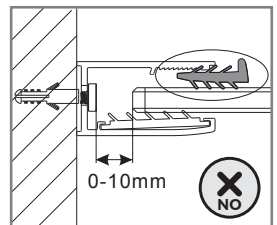
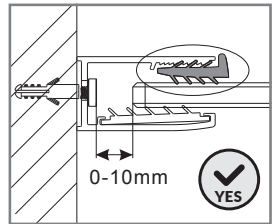
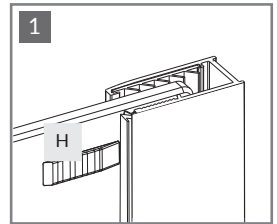
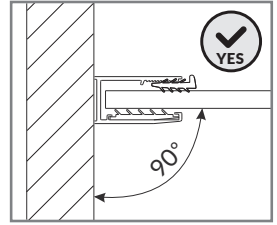
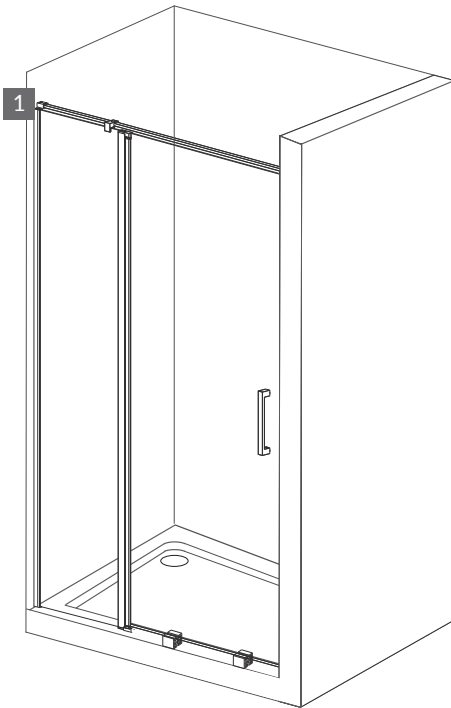
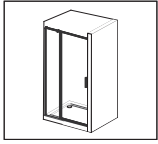

H



x1



16.

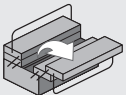
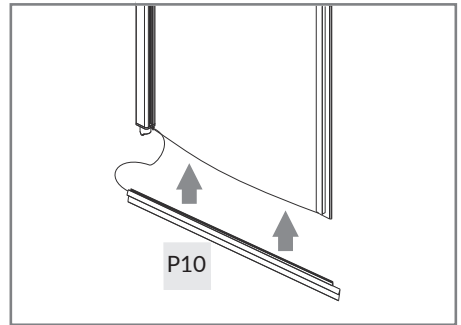
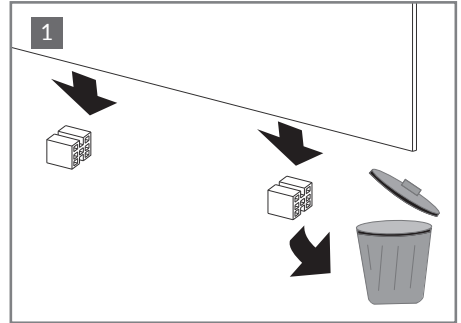
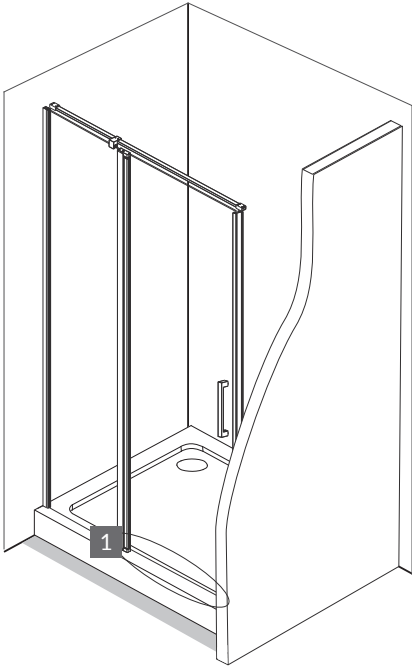
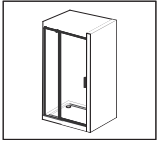

P10

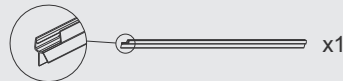

17.

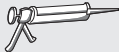
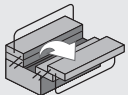
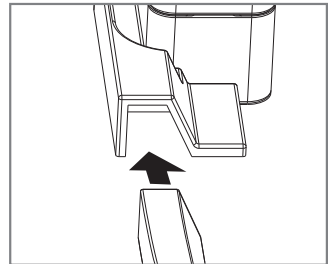
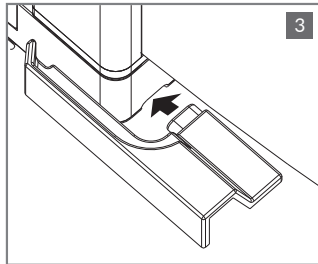
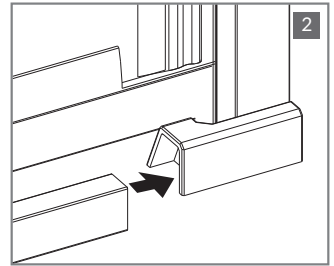
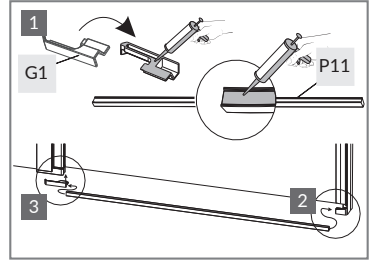
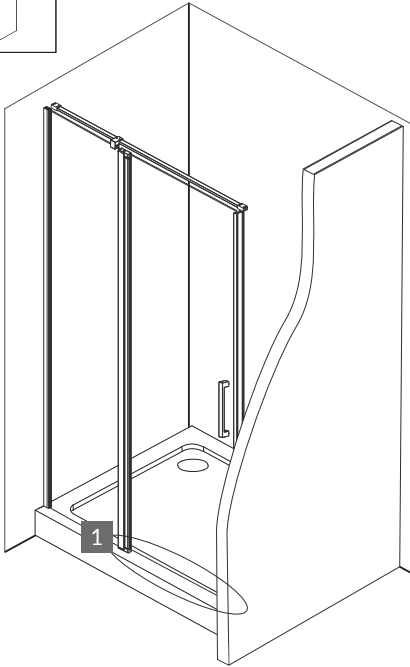
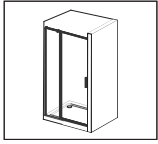

P11

G1



x1

x1



18.

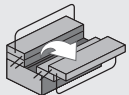
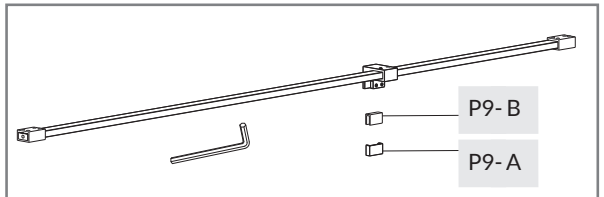
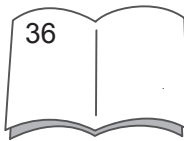
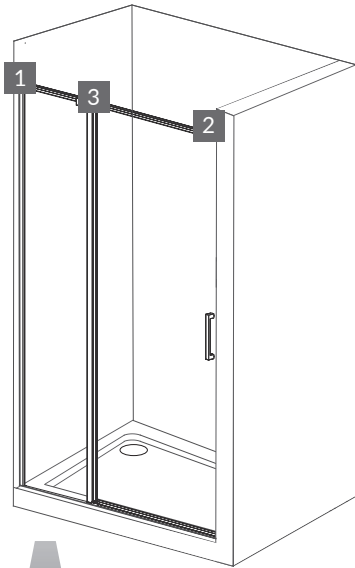
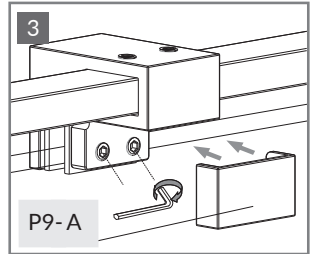
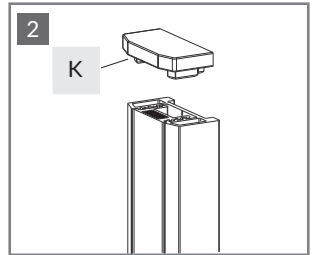
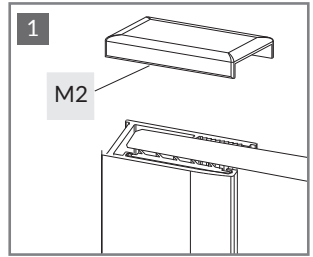
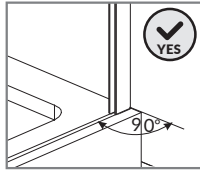
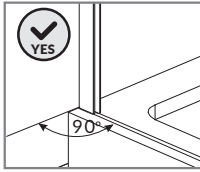
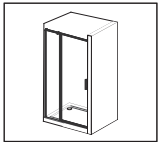

M2



x1

K



x1



19.

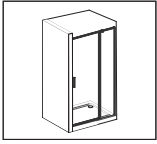

SIZE	X(mm)
800×1950	790-800
900×1950	890-900
1000×1950	990-1000

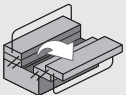
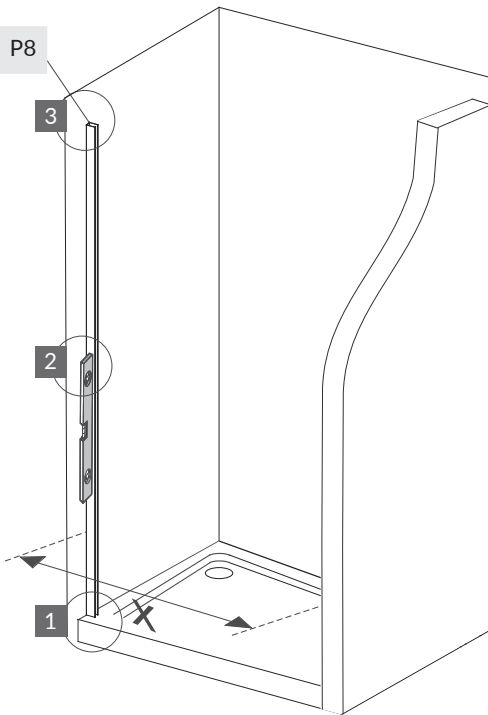
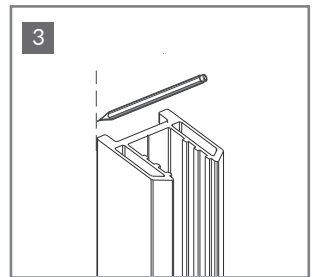
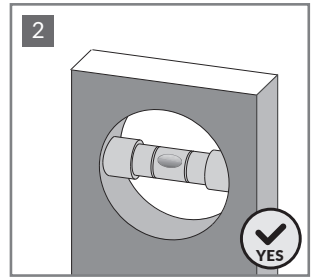
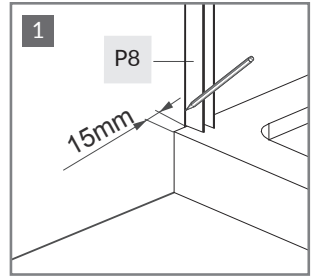

P8



20.

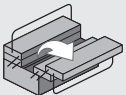
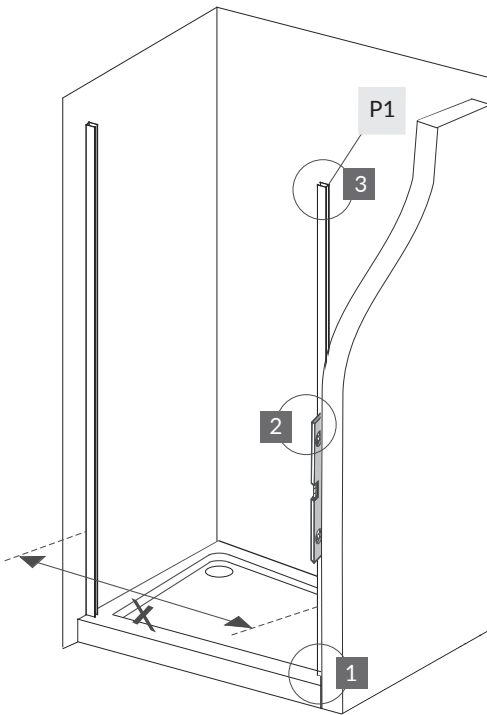
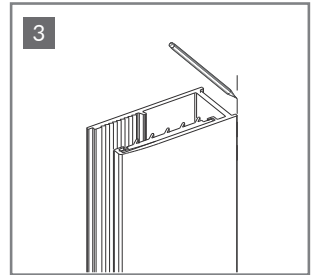
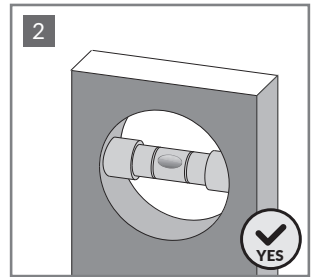
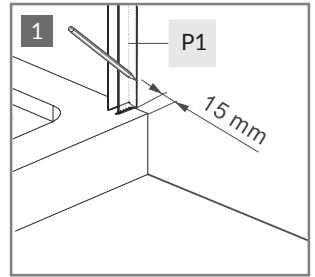
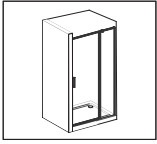

P1



x1



21.

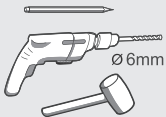
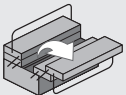
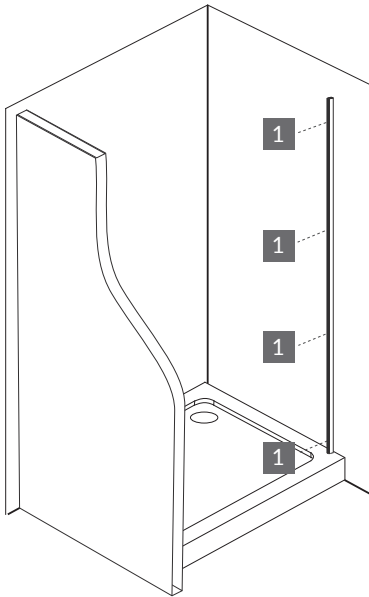
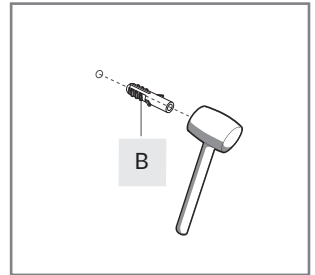
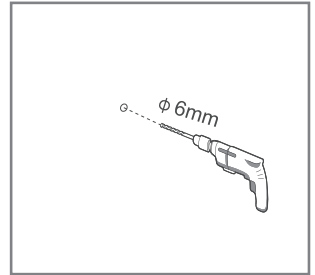
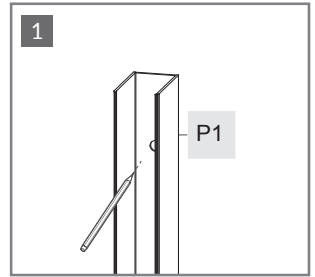
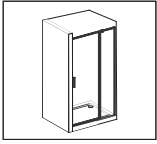

B



x4

P1



x1



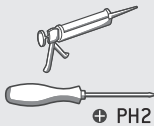
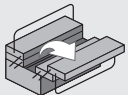
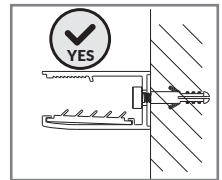
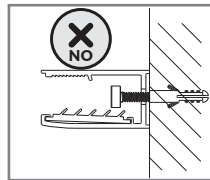
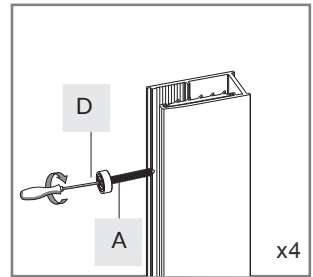
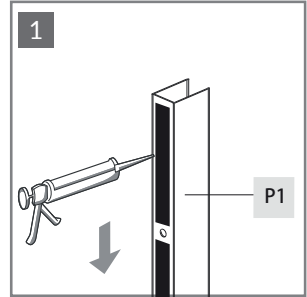
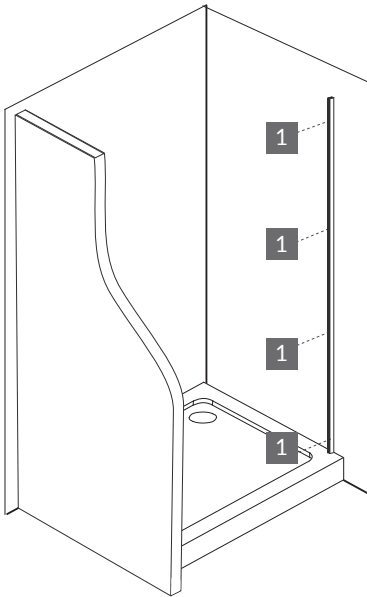
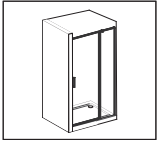

A

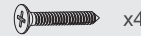

D



P1



23.

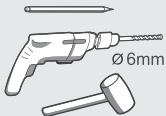
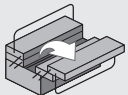
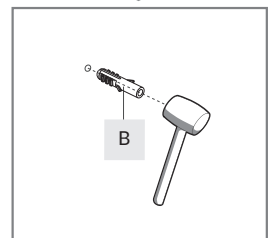
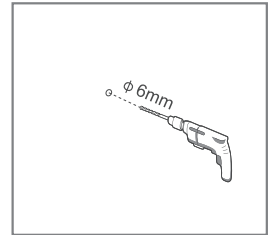
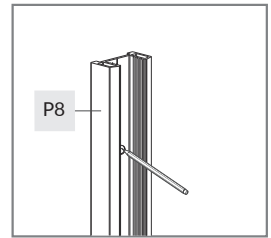
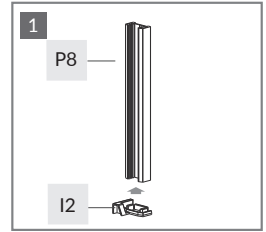
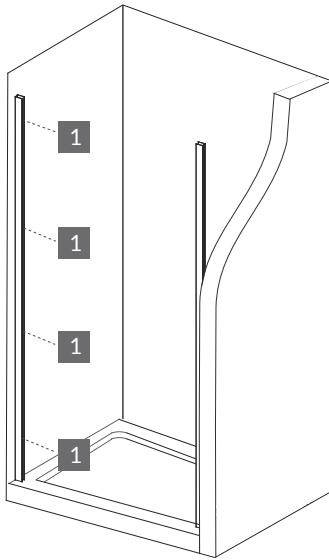
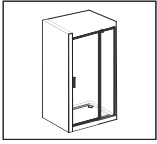

B



x4

I2



x1

P8



x1



24.

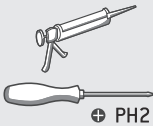
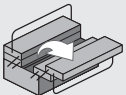
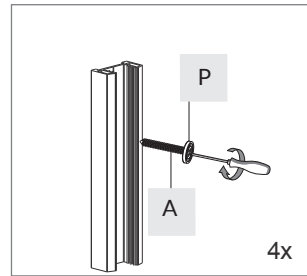
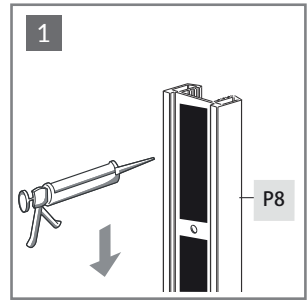
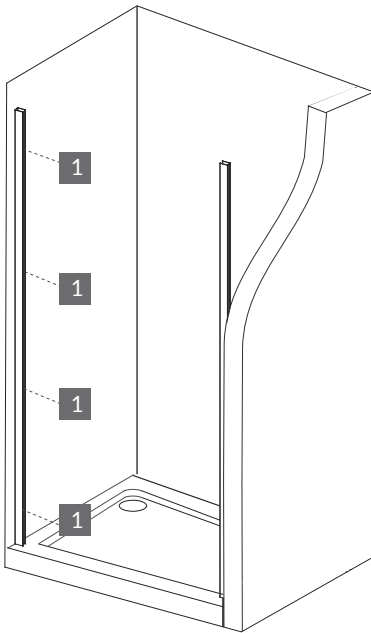
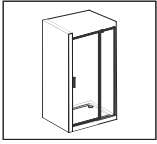

A
P
P8

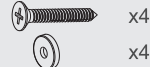

x4

x4



25.

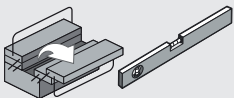
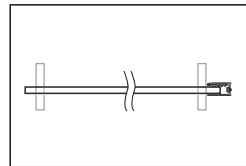
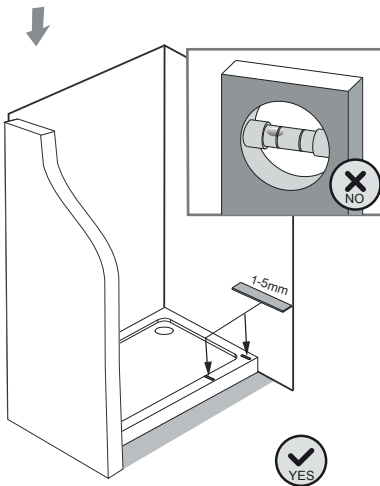
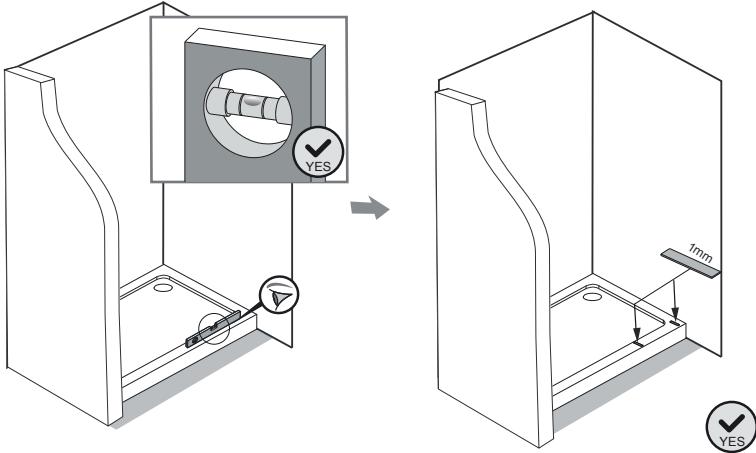
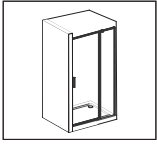

F1



x4

F2



x4

F3



x4



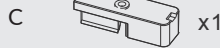
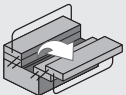
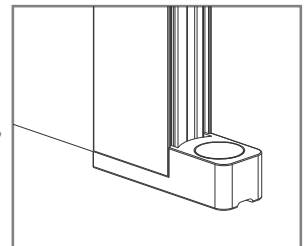
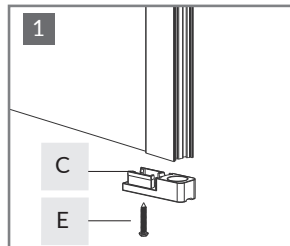
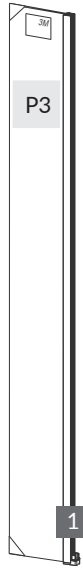
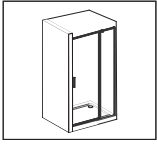

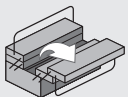
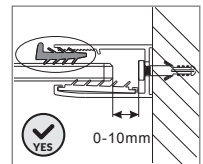
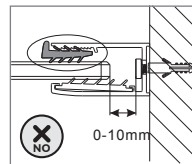
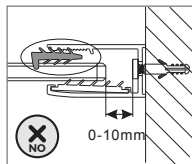
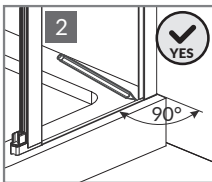
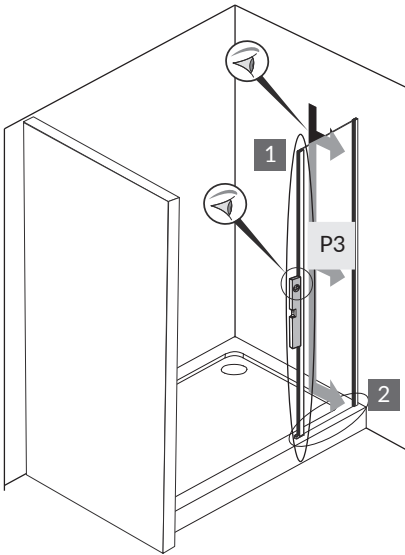
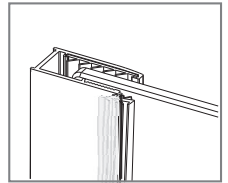
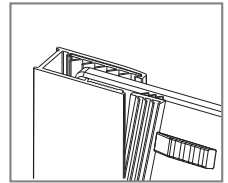
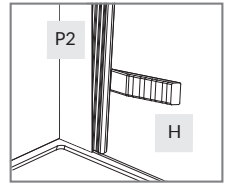
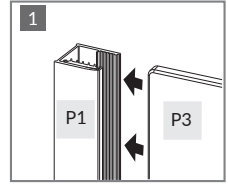
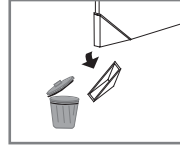
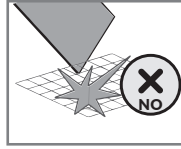
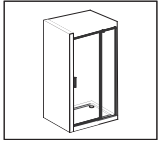

P2

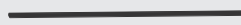

x1

H



x1



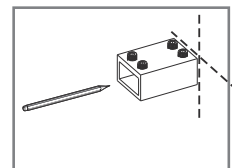
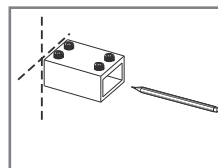
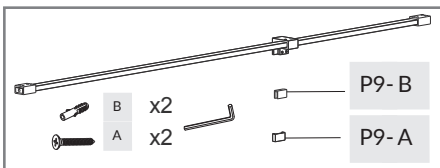
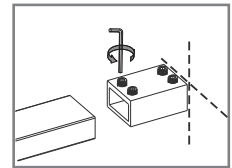
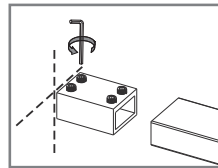
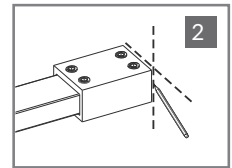
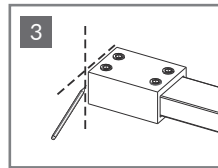
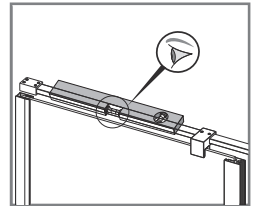
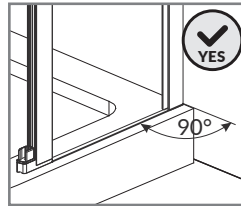
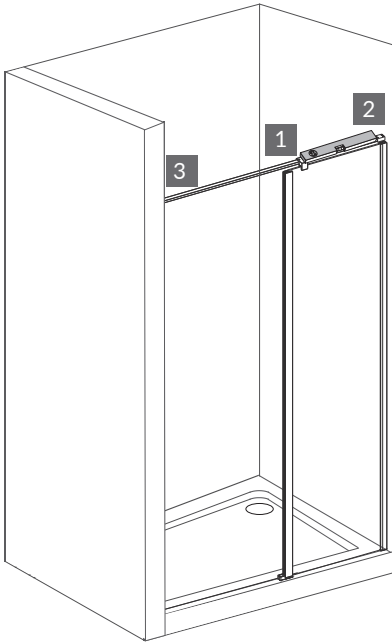
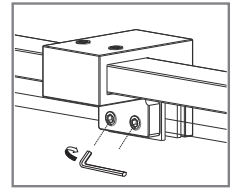
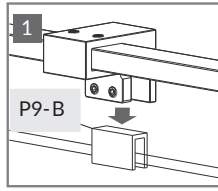
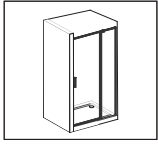

29.

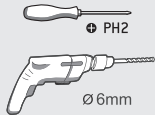
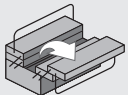
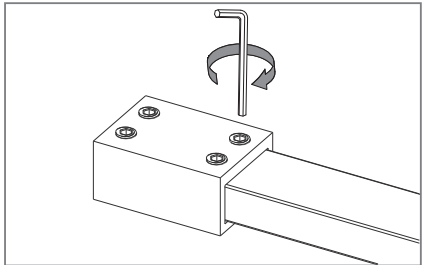
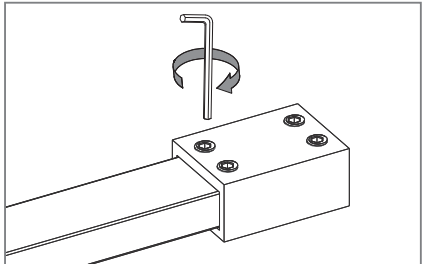
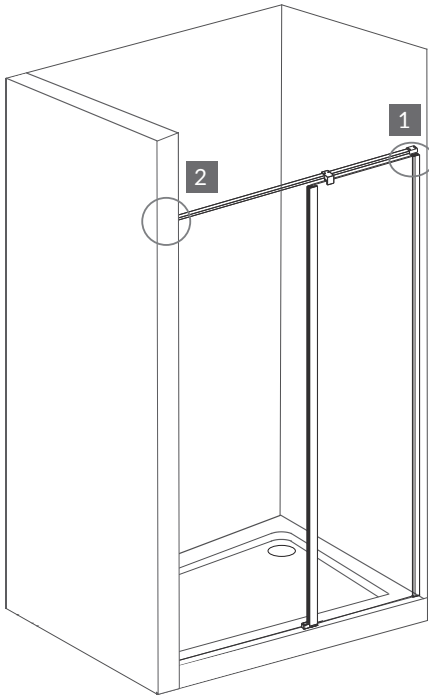
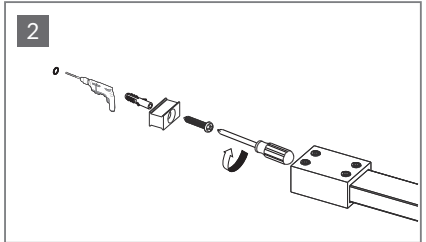
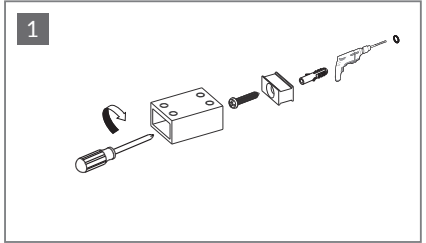
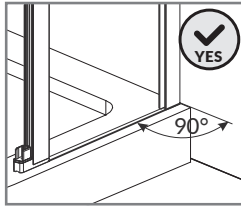
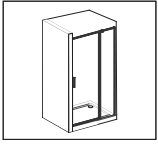

P9

B

A

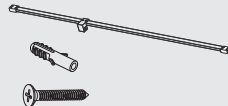

x1

x2

x2



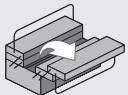
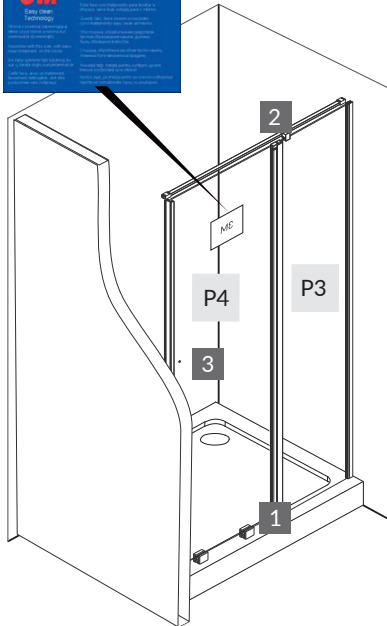
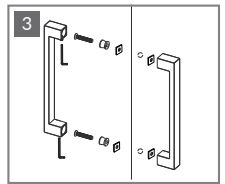
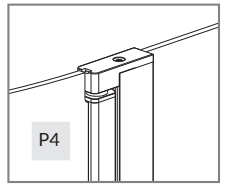
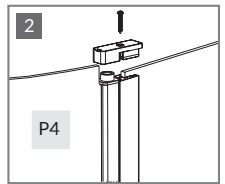
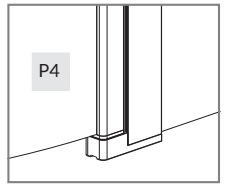
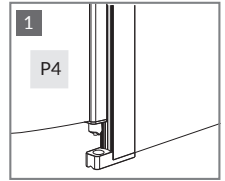
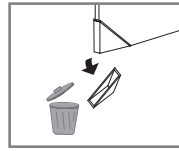
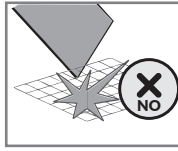
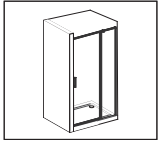

N2



x2

C

P5



x1

E

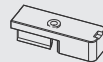

x1



x1



31.

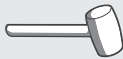
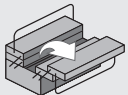
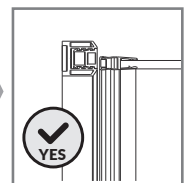
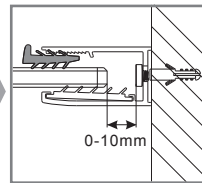
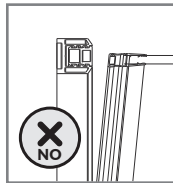
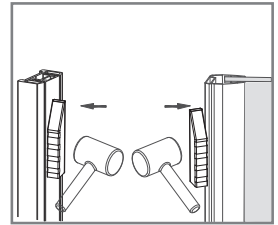
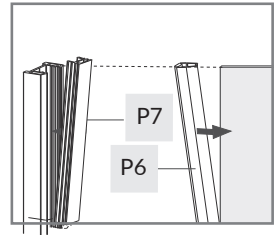
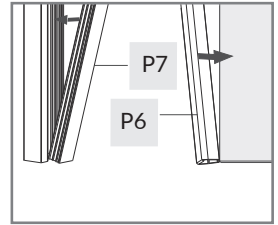
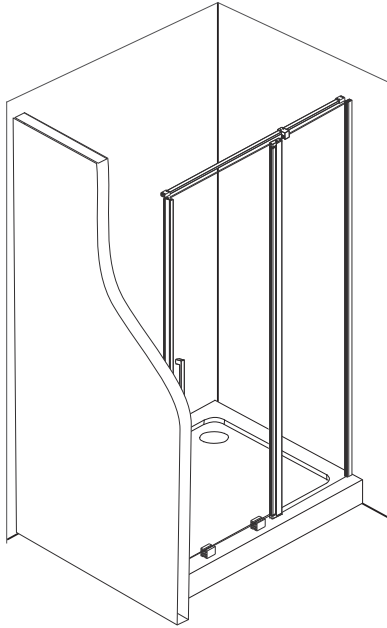
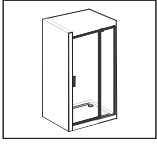

P6



x1

P7



x1

H



x1



32.

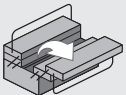
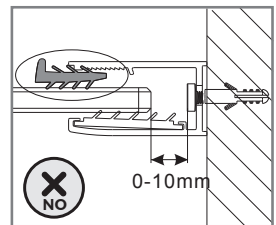
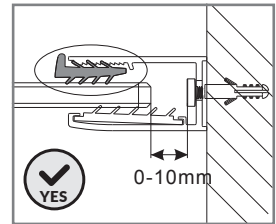
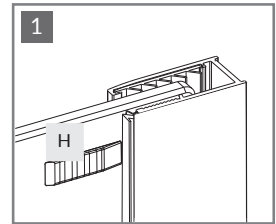
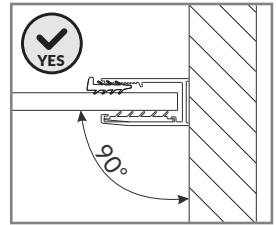
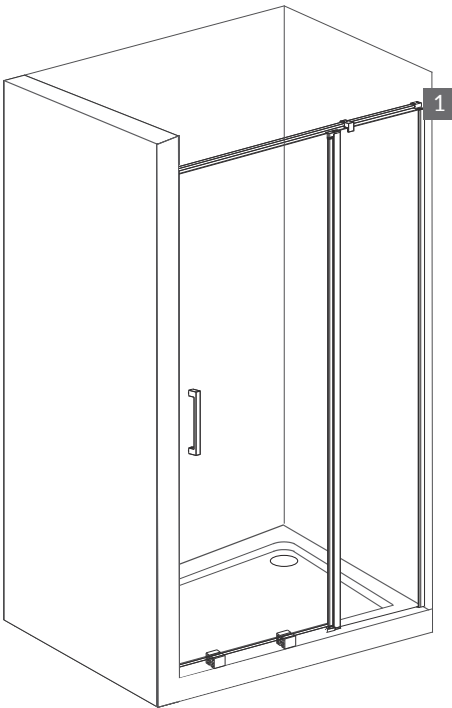
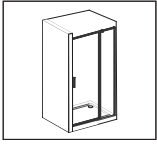

H



x1



33.

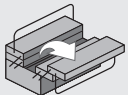
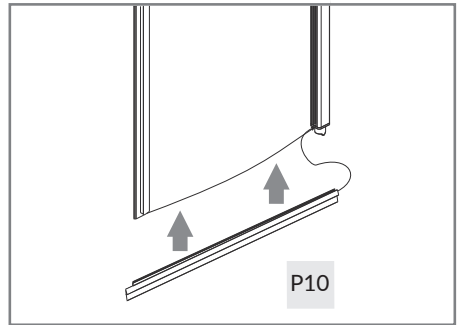
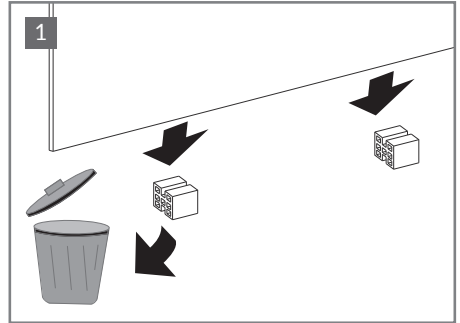
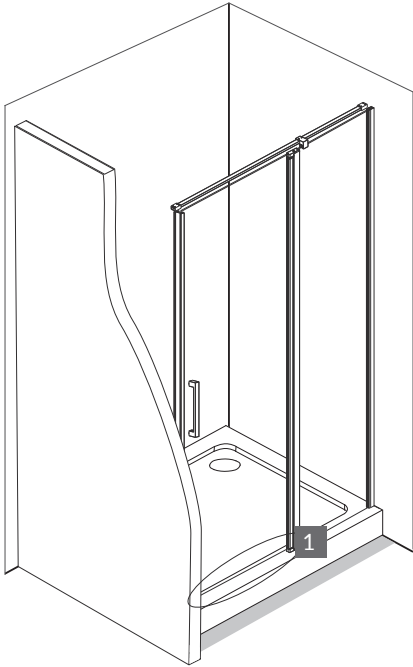
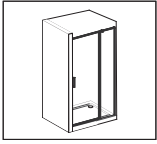

P10



x1



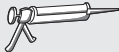
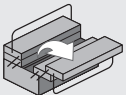
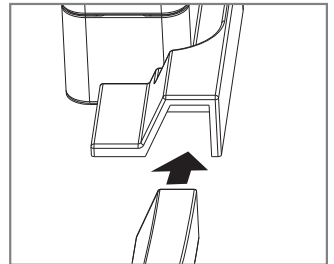
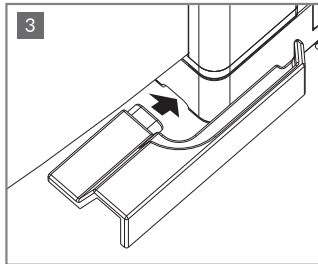
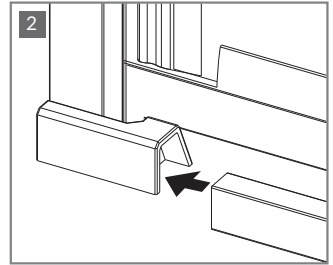
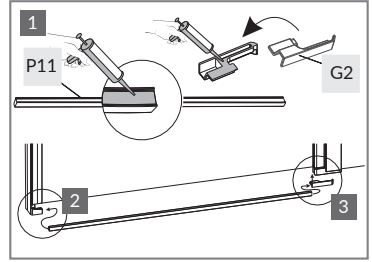
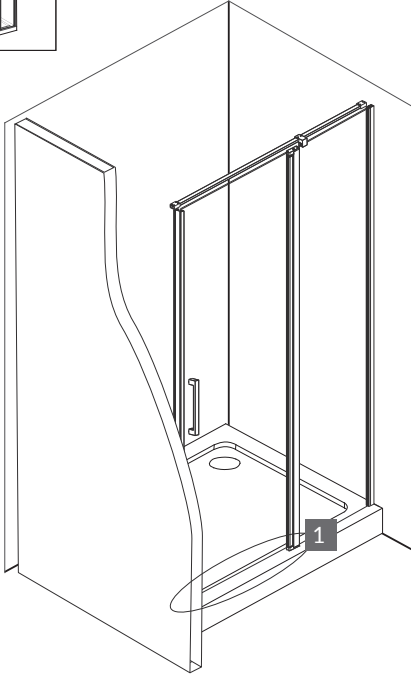
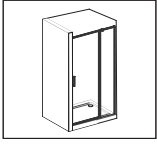

P11

G2



x1



x1



35.

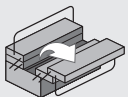
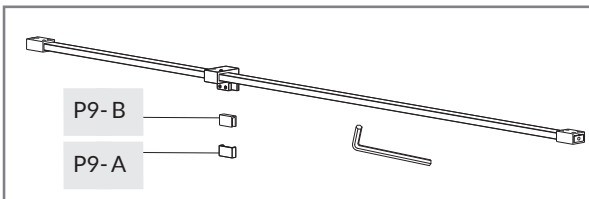
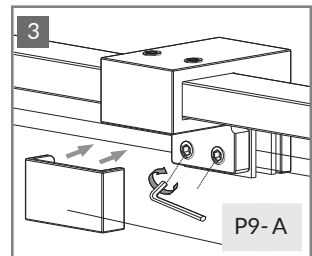
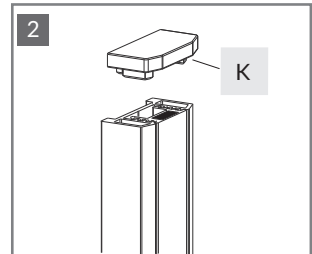
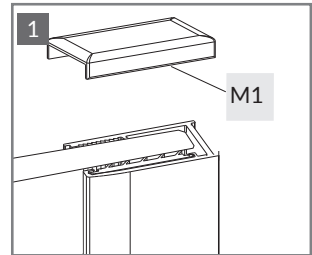
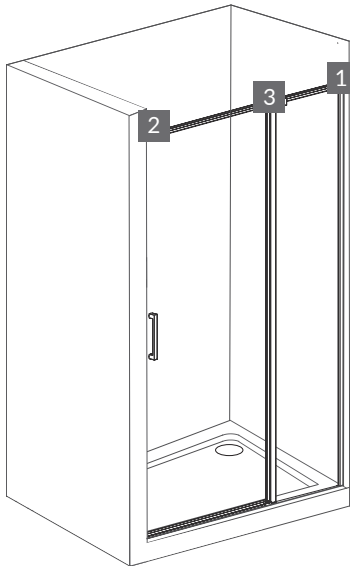
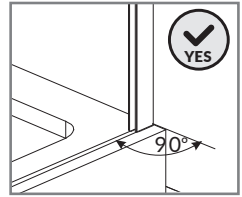
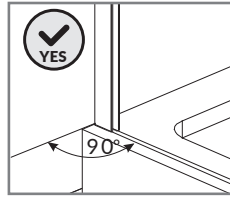
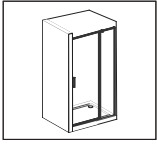

M1

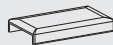

x1

K

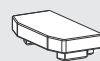

x1



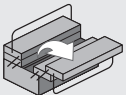
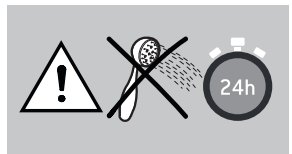
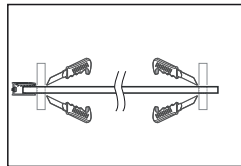
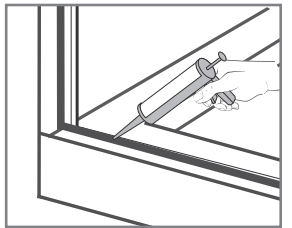
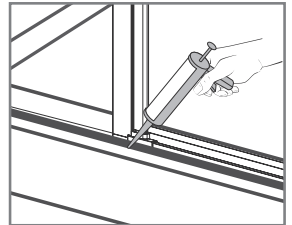
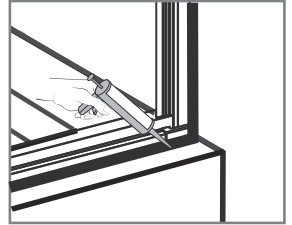
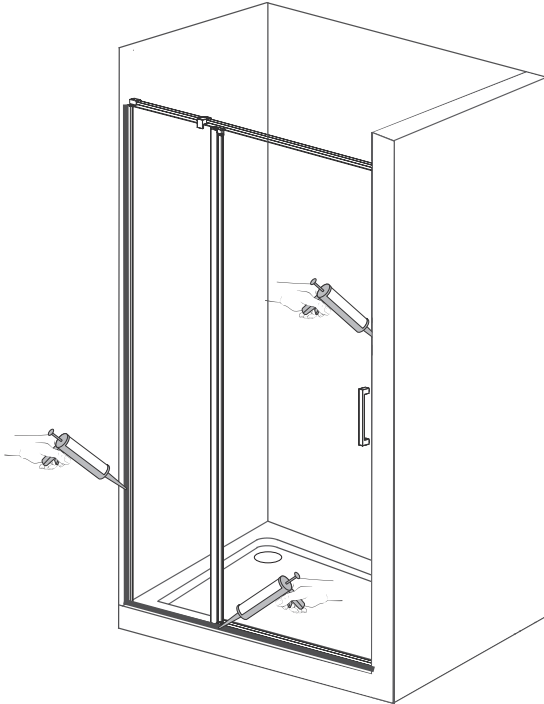
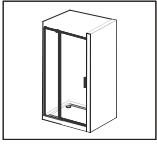



6.5 < PH < 7.5

