

# Montážní návod

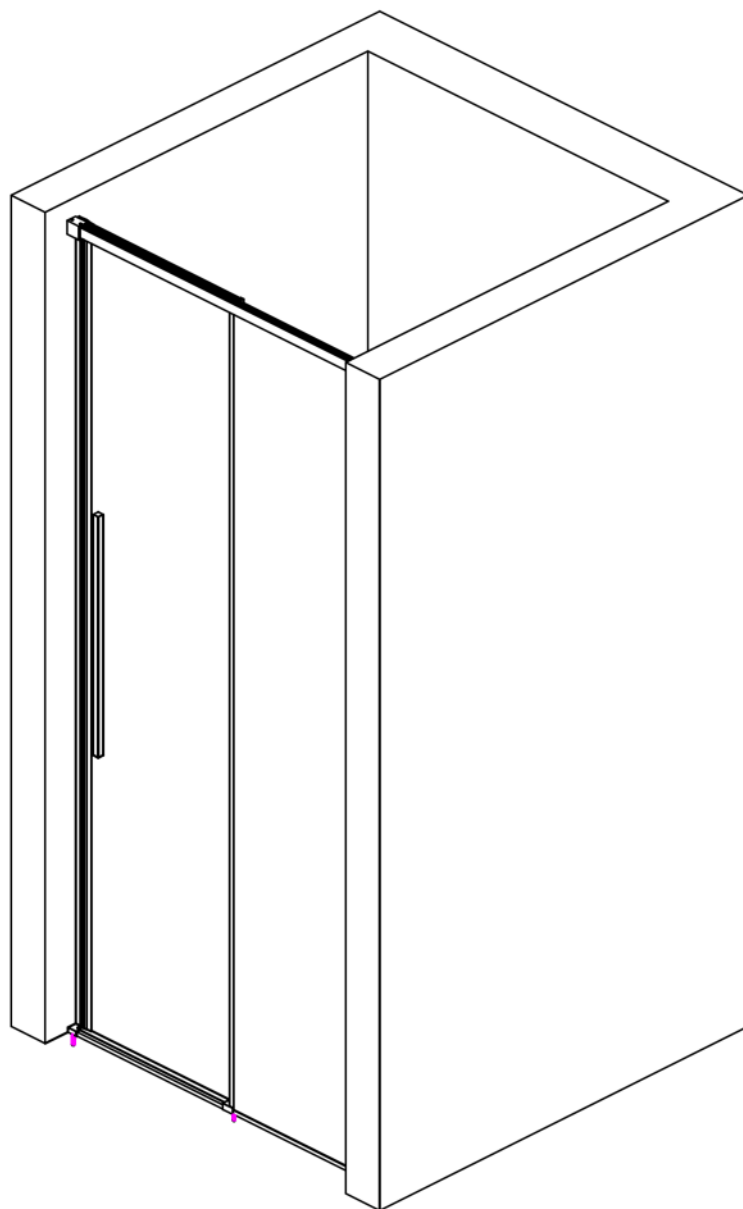

**DVEŘE REA SOLAR**

1. Před zahájením instalace zkontrolujte, zda jsou všechny prvky obsažené v jsou v balení a nejsou poškozeny. V případě poškození nebo chybějících komponentů neprodleně kontaktujte prodejce.

**POZNÁMKA: NEINSTALUJTE POŠKOZENÉ SOUČÁSTI**

a) Před instalací si prosím přečtěte návod, zkontrolujte, zda máte všechny požadované nástroje a součásti dveří. Postupujte podle pokynů.







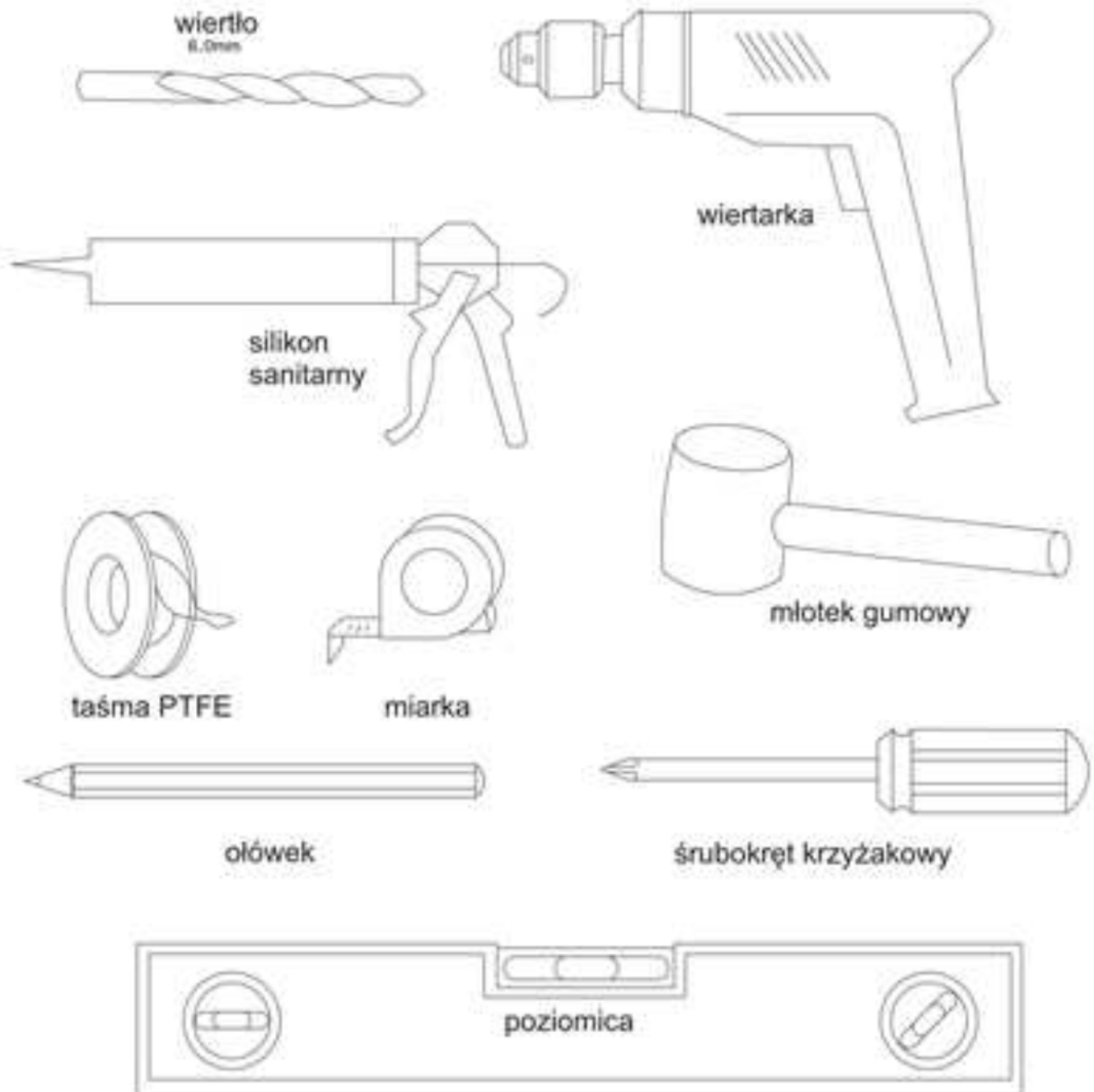

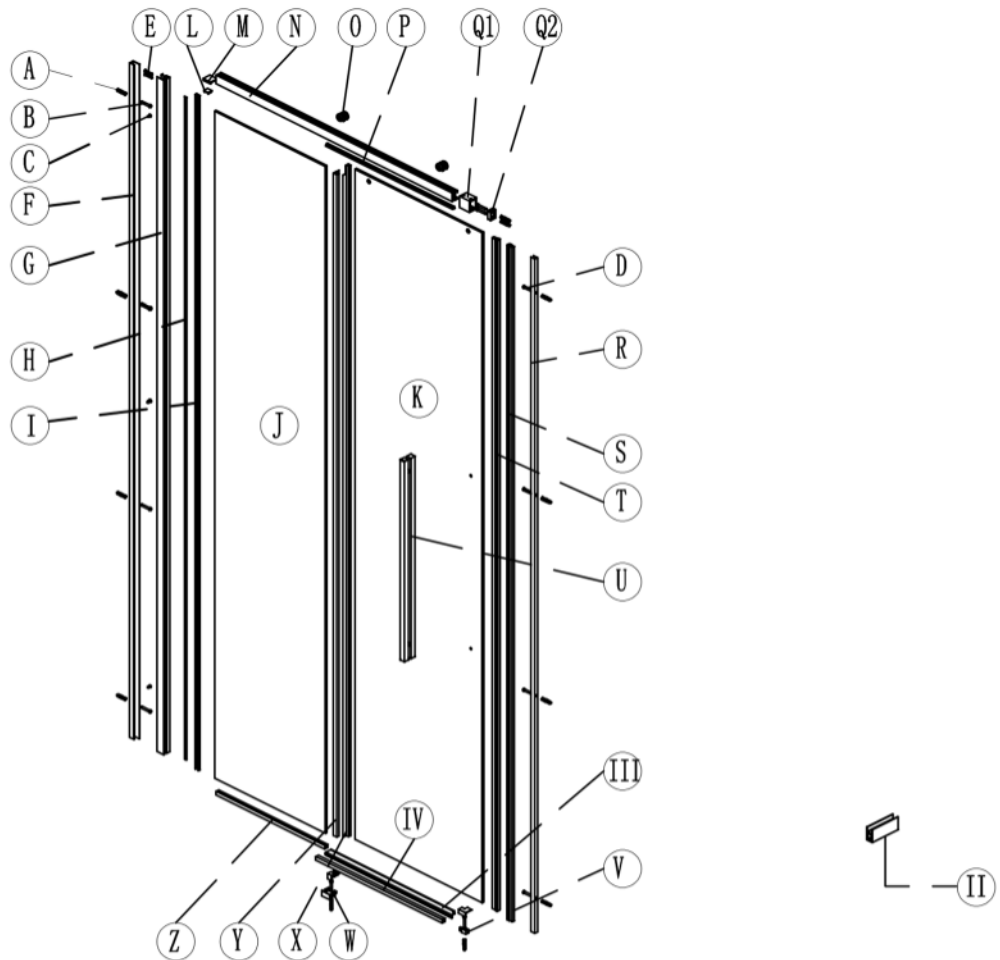





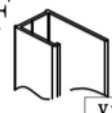



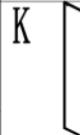

















b) Při instalaci nepoužívejte ostré nebo tvrdé nástroje, abyste zabránili poškození skleněných částí. Pokud je to nutné, použijte pouze gumovou paličku.

2. Potřebné nástroje (nejsou součástí balení):

Vrták, Vrtačka, Silikon, Lepící páska, Tužka, Metr, Gumová palička, Křížový šroubovák, Vodováha,





 X12	 ST4. 2x32 X8	 ST3. 5x9. 5 X3	 ST4. 2x32 X4	 ST3. 9x32 X2	 X1	 X1	 X1
 X1	 X1	 X1	 X1	 X1	 X1	 X2	 X1
 X1	 X1	 X1	 X1	 X1	 v1 v2 X1	 w1 w2 X1	 X1
 X1	 X1	 X2	 X1	 X1			
							
							

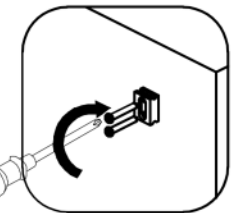
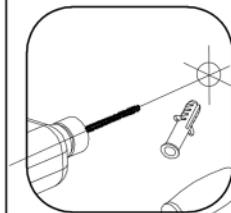
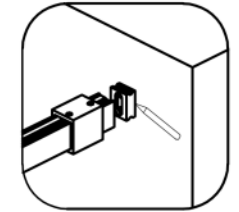
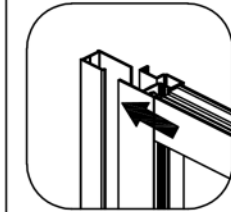
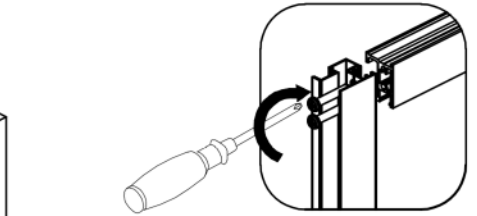
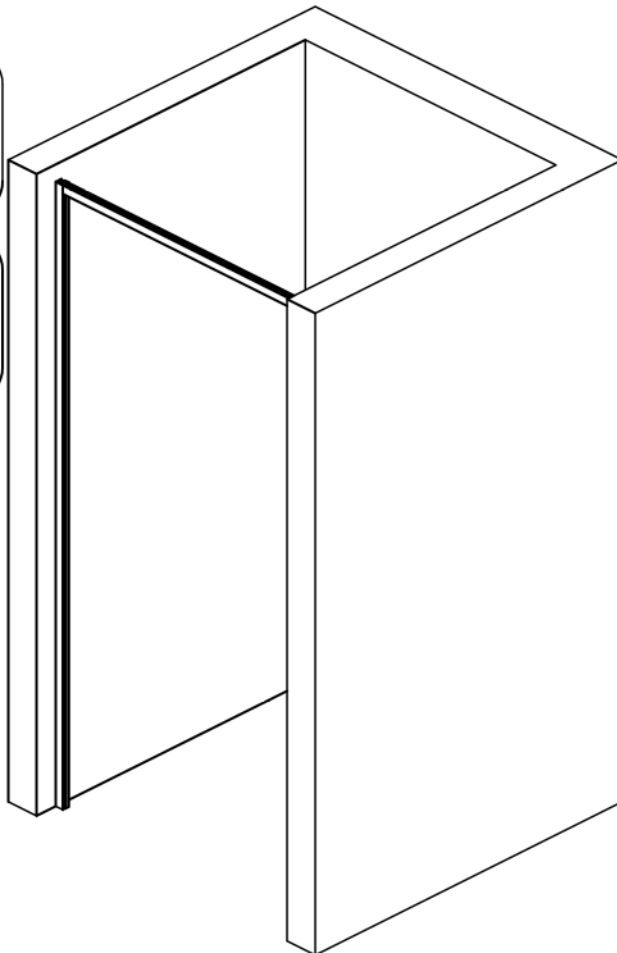
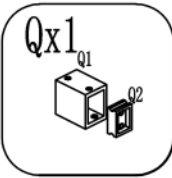
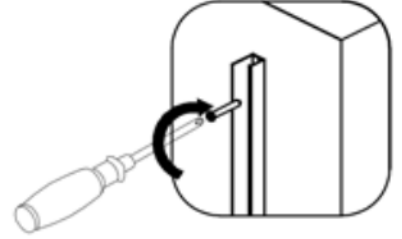
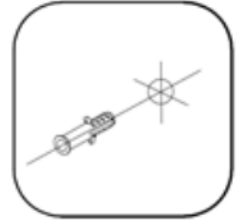
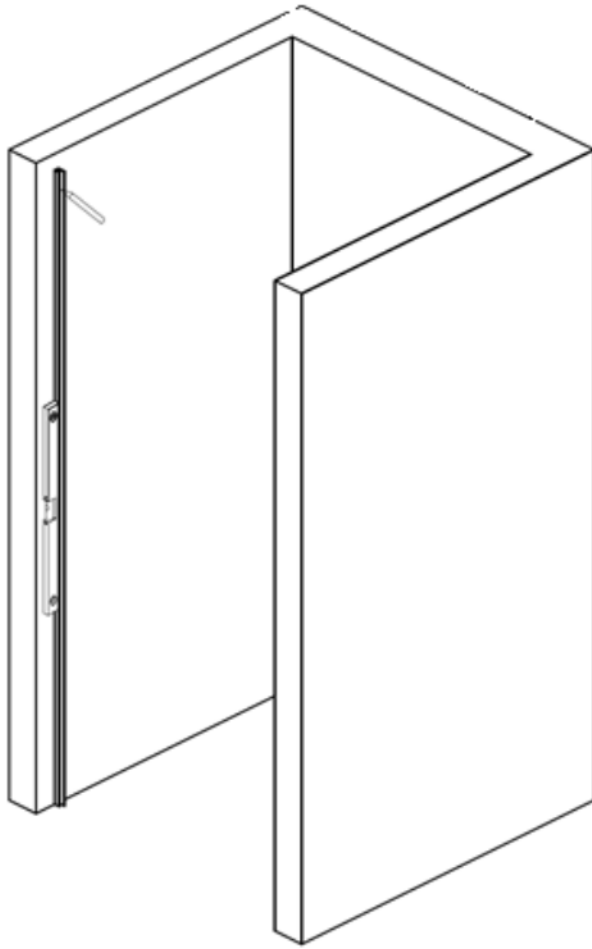

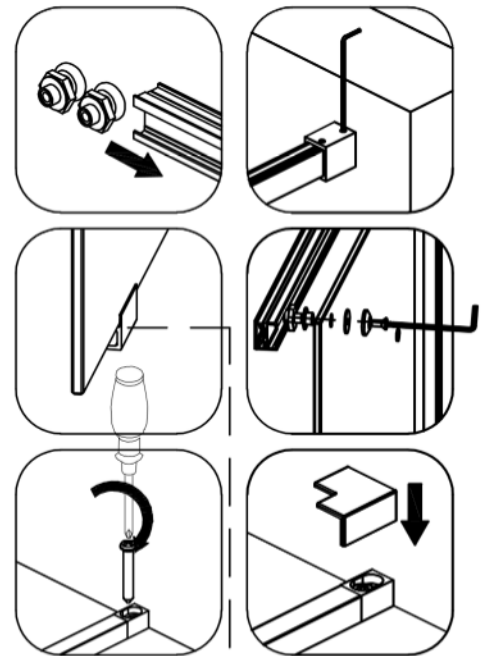
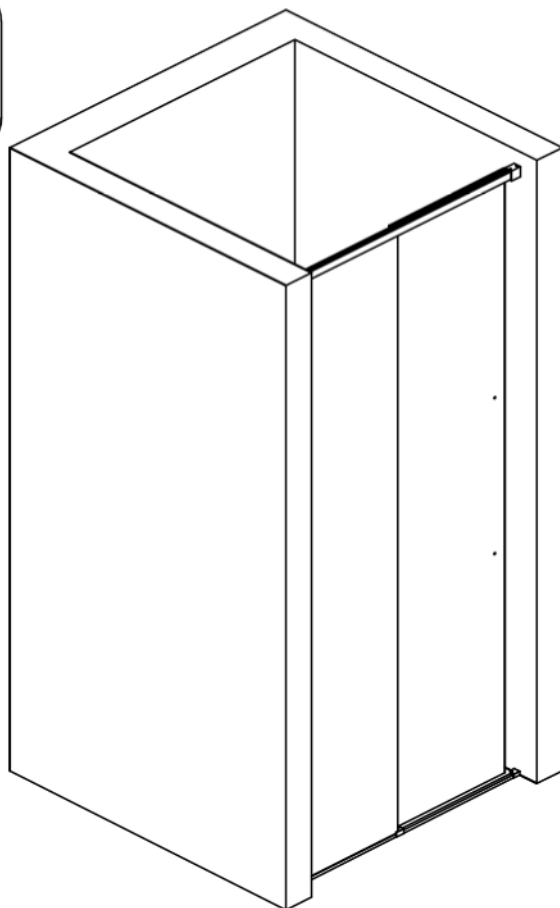
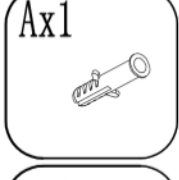
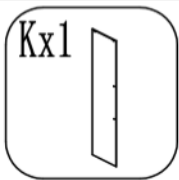
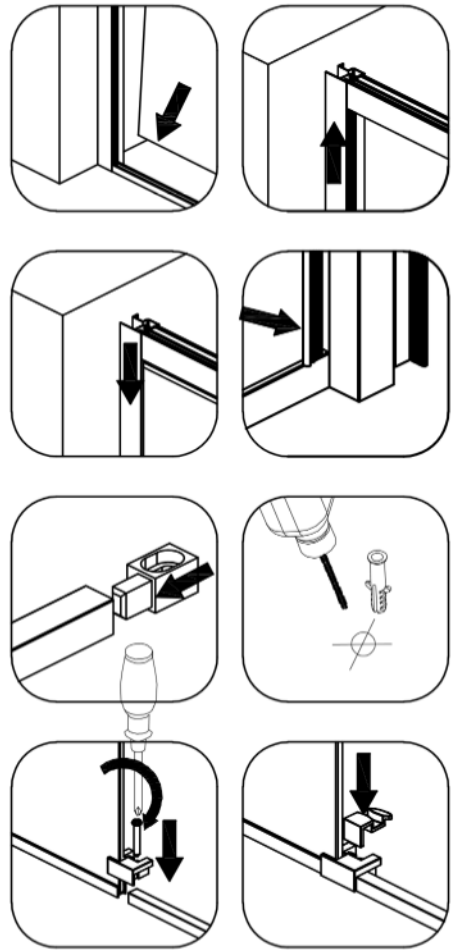
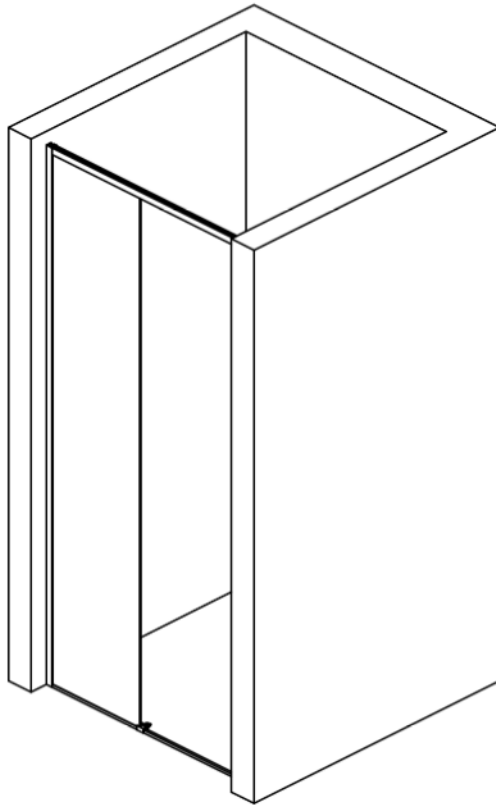
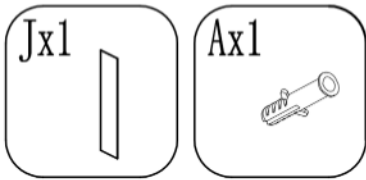

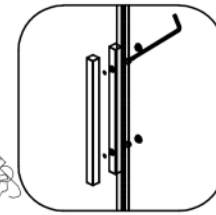
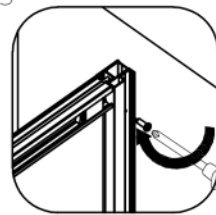
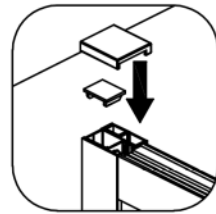
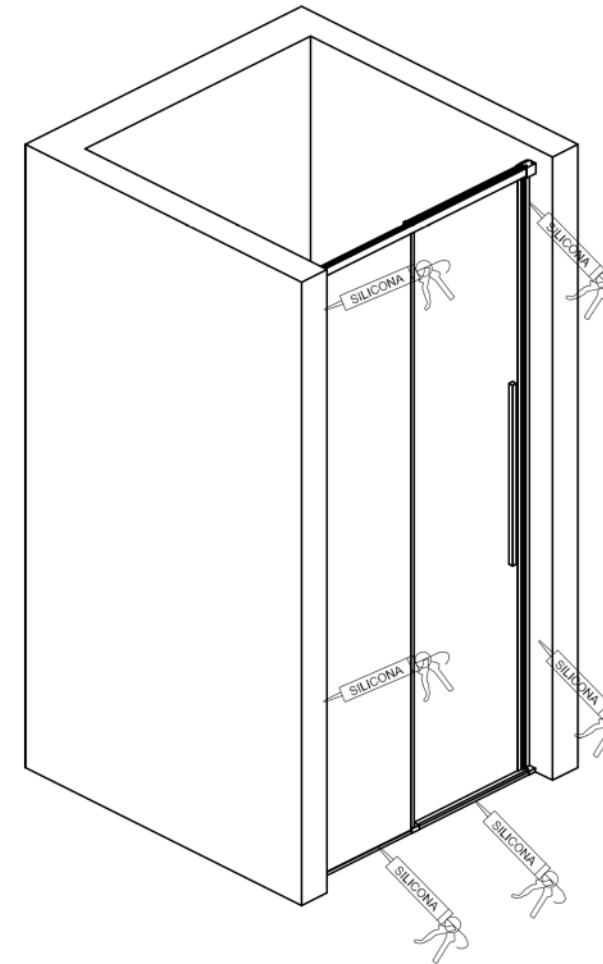
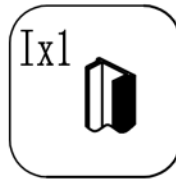
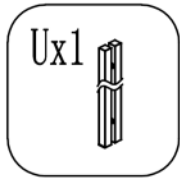
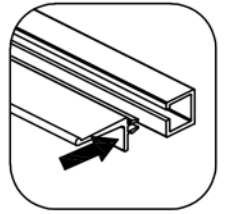
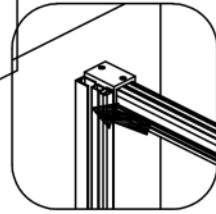
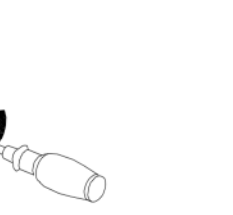
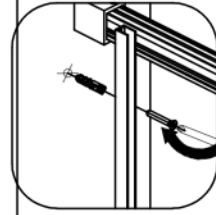
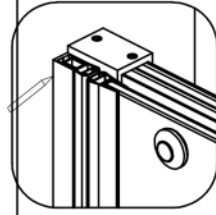
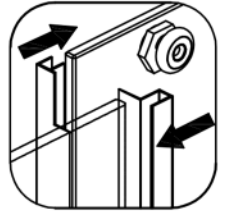
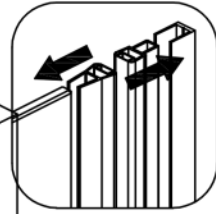
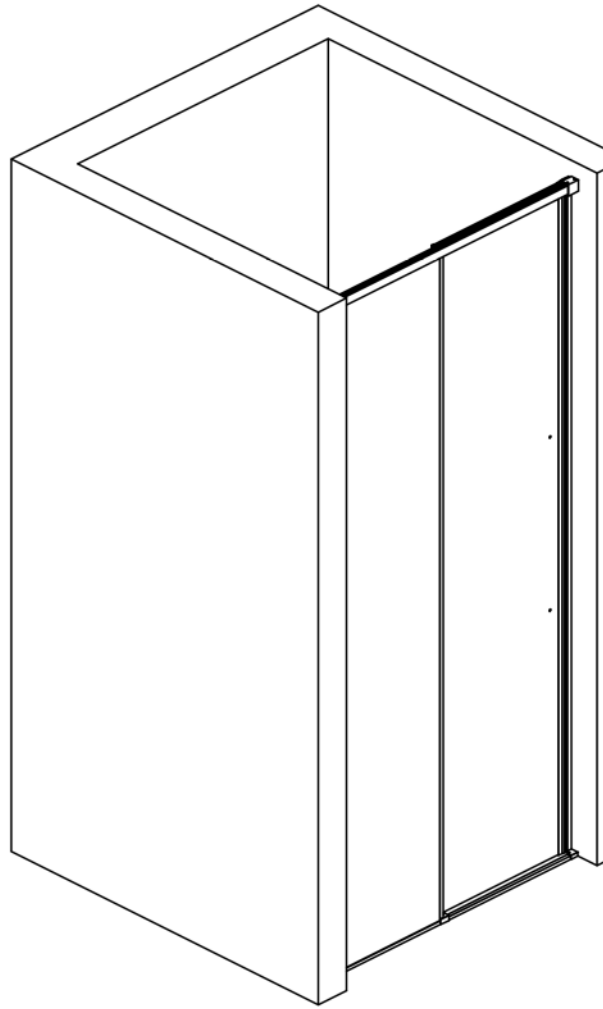
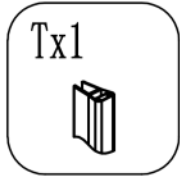

SILICONA

SILICONA

SILICONA

SILICONA

SILICONA