

Rea

ŁAZIENKA Z WYOBRAŻNIĄ

INSTRUKCJA MONTAŻU

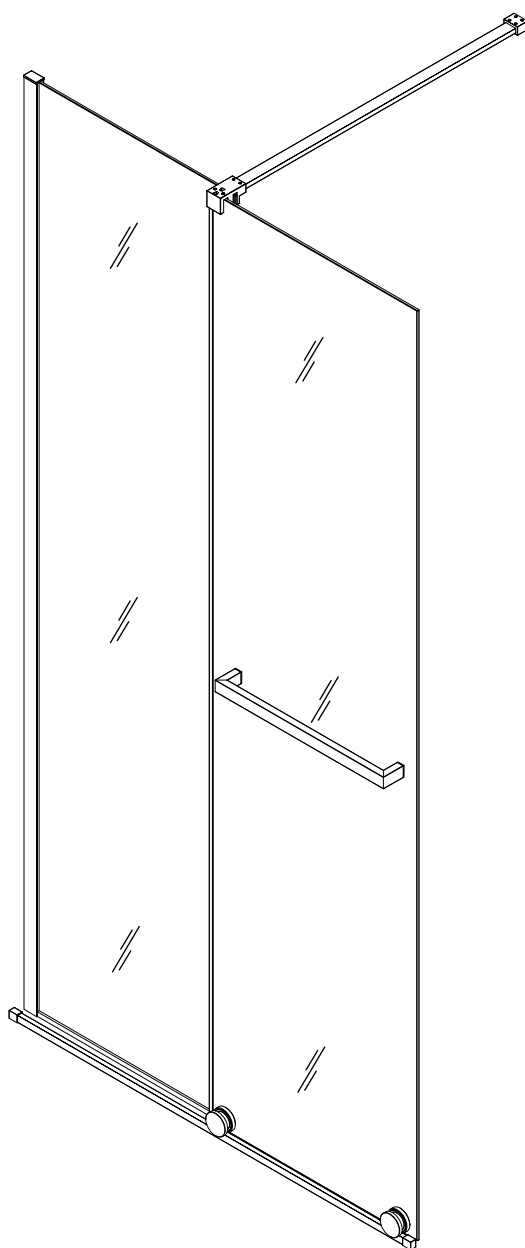

CORTIS

1. Uwagi dotyczące montażu

Przed rozpoczęciem montażu prosimy sprawdzić czy wszystkie elementy zawarte w instrukcji znajdują się w opakowaniu oraz czy nie są uszkodzone. W przypadku uszkodzeń lub braków prosimy o pilny kontakt ze sprzedawcą.

UWAGA: NIE MONTOWAĆ ELEMENTÓW USZKODZONYCH

- a) Przed rozpoczęciem montażu proszę zapoznać się z instrukcją, proszę sprawdzić czy ma się wymagane narzędzia i elementy składowe kabiny. Należy postępować zgodnie z instrukcją.
- b) Proszę nie używać ostrych ani twardych narzędzi podczas montażu, aby uniknąć uszkodzenia szyb. W razie potrzeby należy użyć gumowego młotka.

2. Potrzebne narzędzia (nie ma w zestawie):

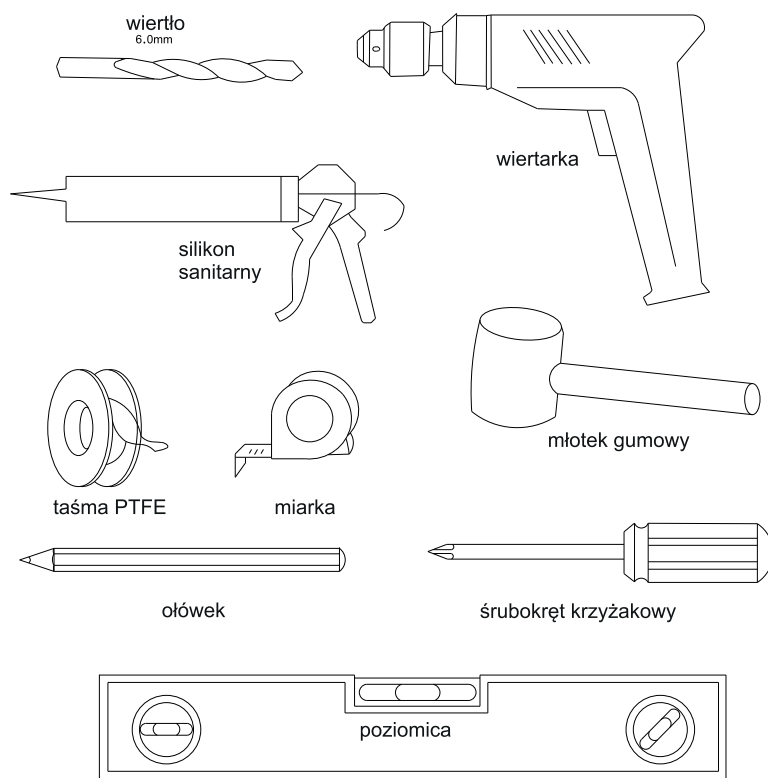

3. UWAGA!

1. Osoby, które czują się słabo lub są po spożyciu alkoholu nie powinny korzystać z kabiny.
2. Osoby cierpiące na choroby serca i wysokie ciśnienie powinny być szczególnie ostrożne w czasie korzystania z kabiny.
3. Dzieci i osoby starsze powinny korzystać z kabiny pod nadzorem osób dorosłych.
4. Proszę zachować szczególną ostrożność w czasie wchodzenia i wychodzenia z kabiny. Aby uniknąć uszkodzeń kabiny i utraty równowagi proszę nie opierać się o ścianę.
5. Czas kąpieli proszę dostosowywać do samopoczucia.
6. Zabrania się odkręcania jedynie wody gorącej w czasie dostosowywania temperatury wody.
7. Zabrania się palić w kabinie.

4. Czyszczenie i konserwacja

1. Codzienne czyszczenie może być wykonywane za pomocą zwykłych środków czystości i miękkiej szmatki. Nie wskazane jest używanie środków bazujących na acetonie i amoniaku.
2. Zacieki mogą być usuwane przy pomocy octu.
3. Po czyszczeniu proszę zostawić drzwi otwarte, aby szybciej wyschły.

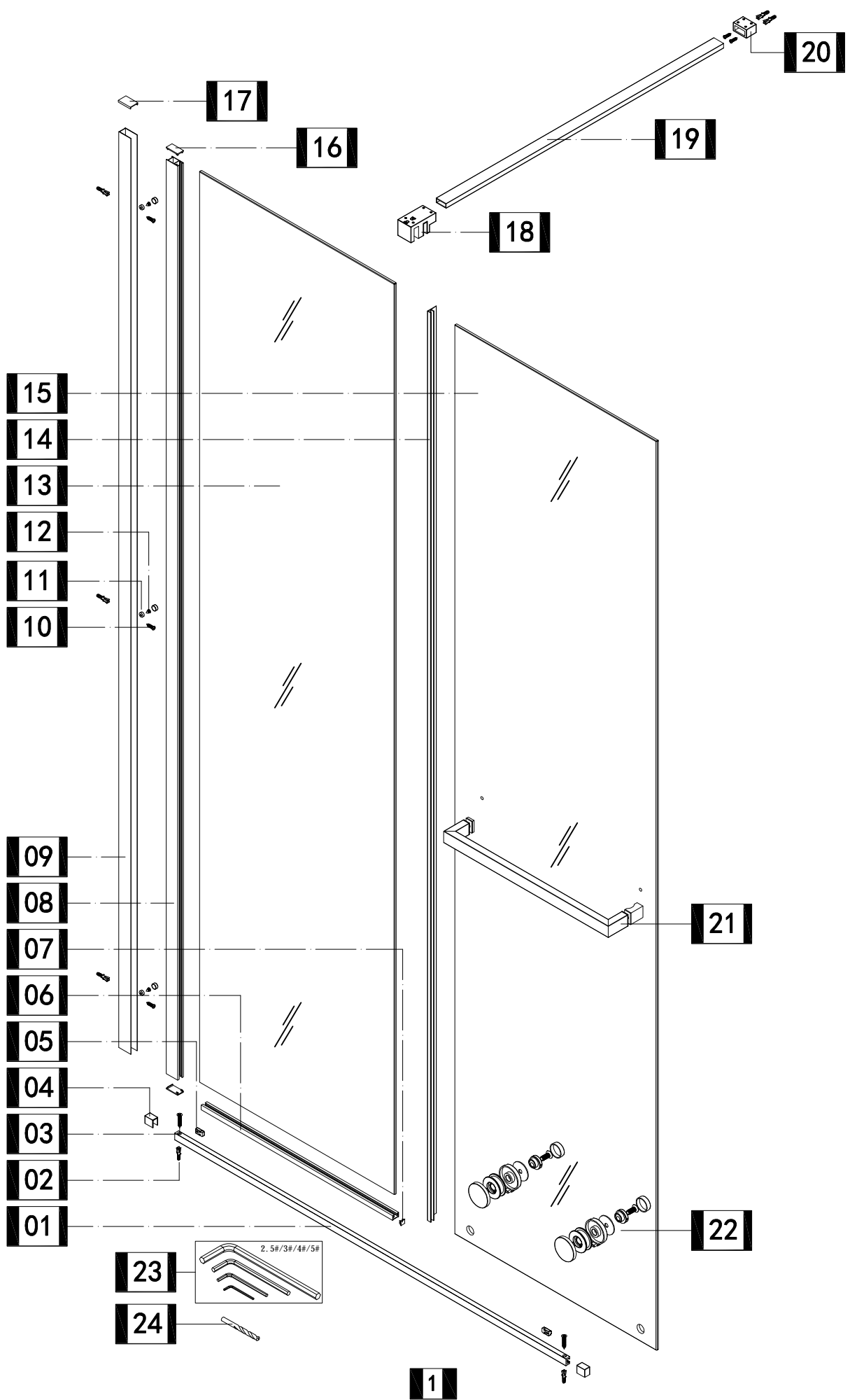

POTRZEBNE NARZEDZIA

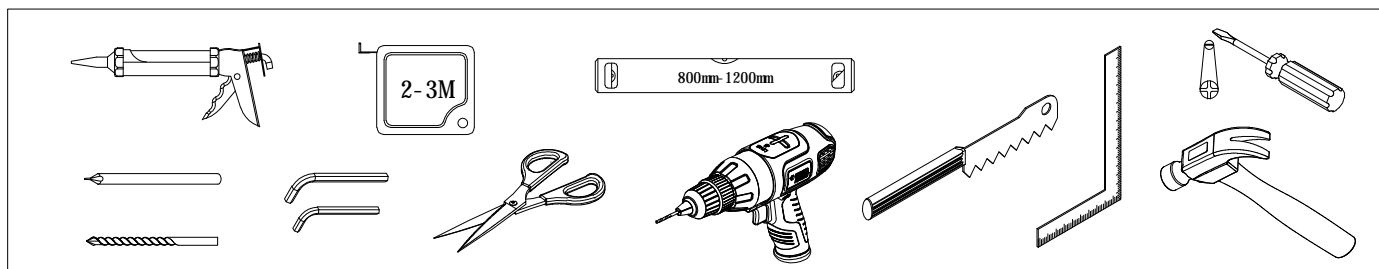

WSZYSTKIE CZĘŚCI

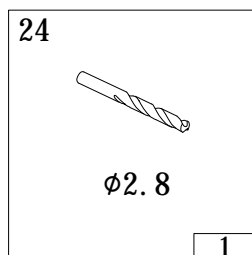
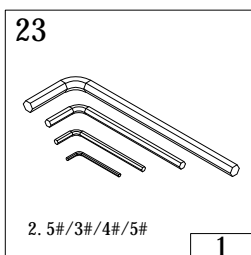
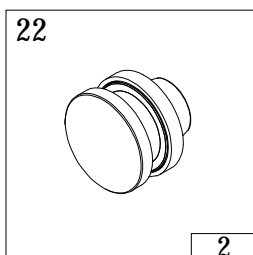
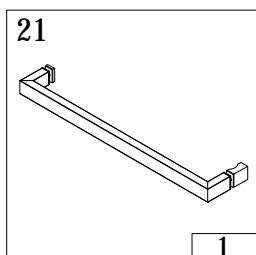
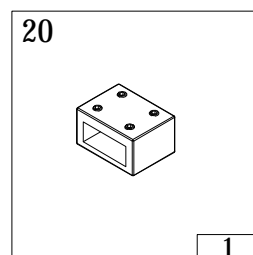
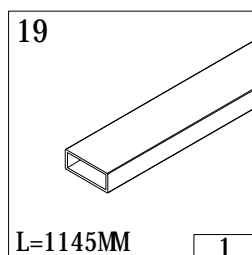
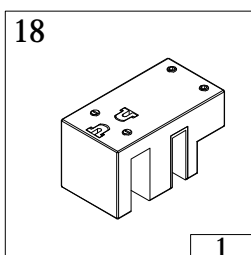
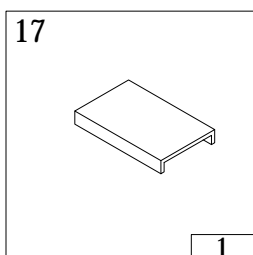
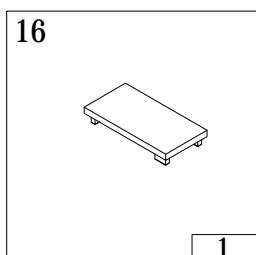
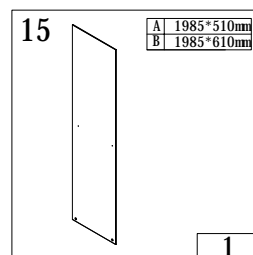
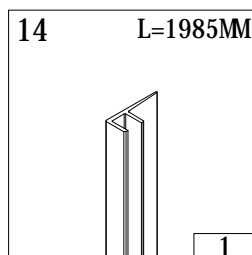
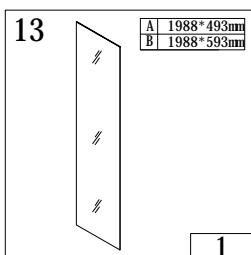
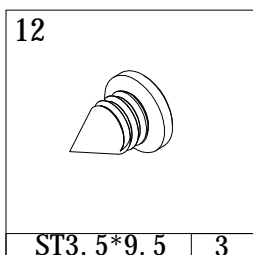
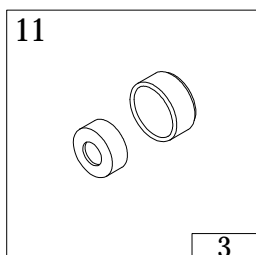
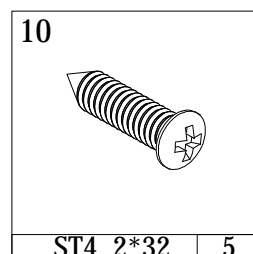
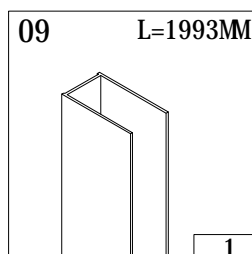
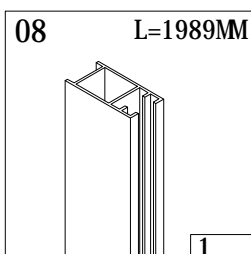
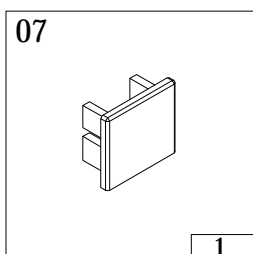
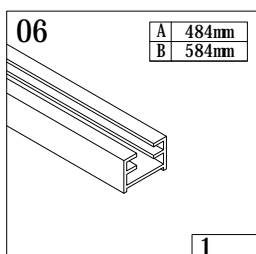
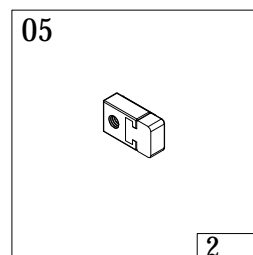
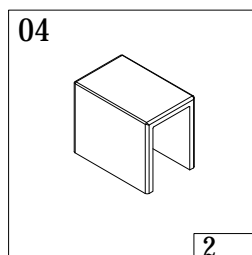
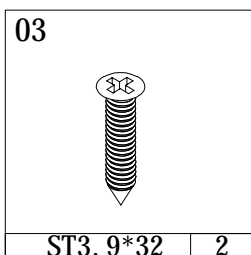
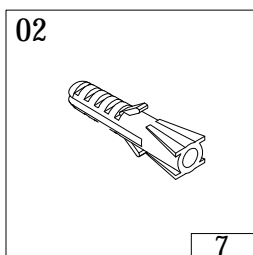
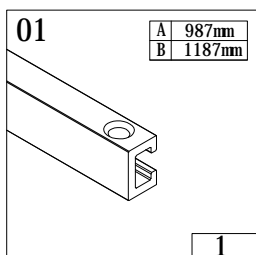

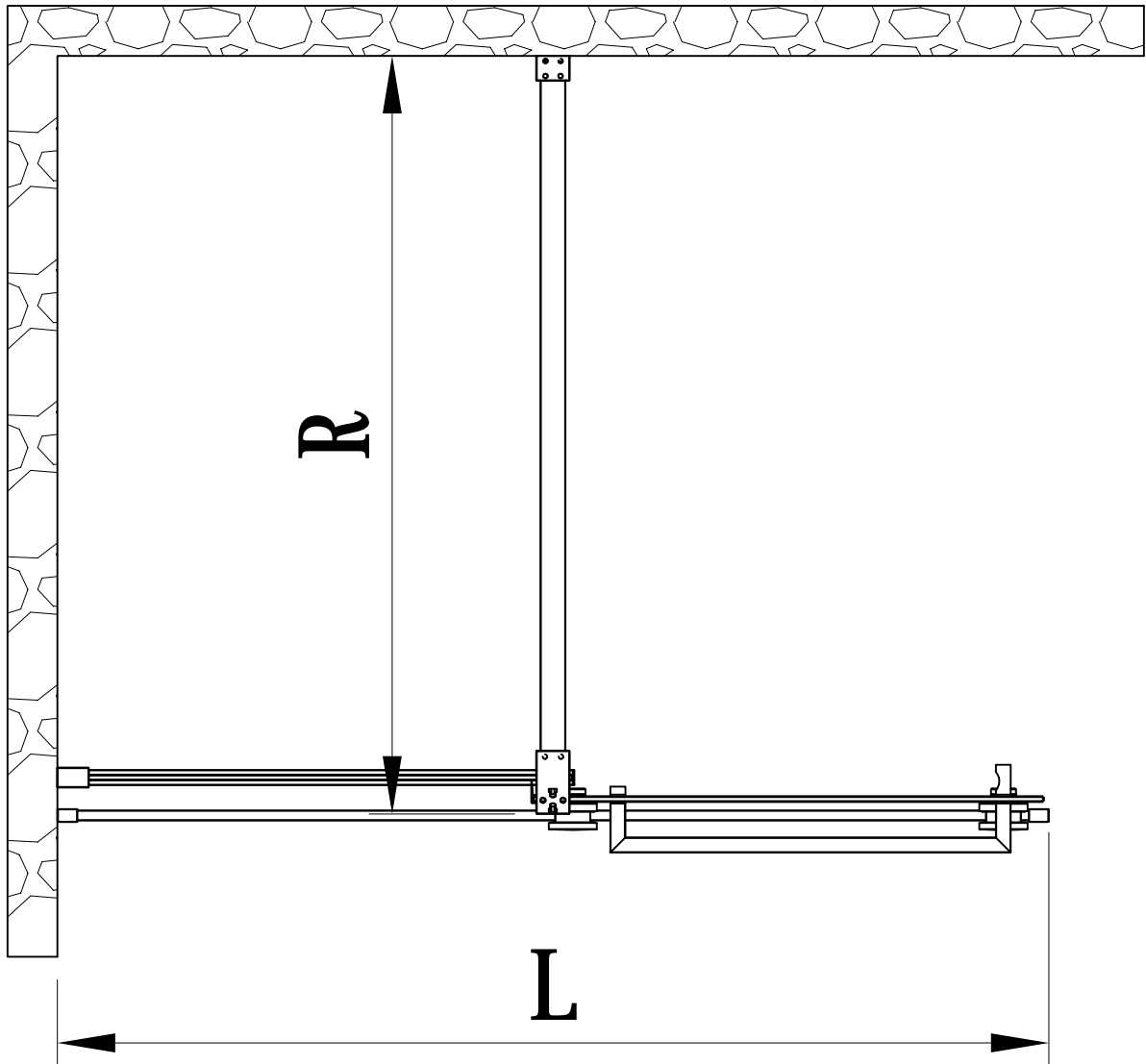

L	R
990- 1000	1200
1090- 1100	
1190- 1200	

