

# Rea

ŁAZIENKA Z WYOBRAŻNIĄ

## MONTÁŽNÍ NÁVOD

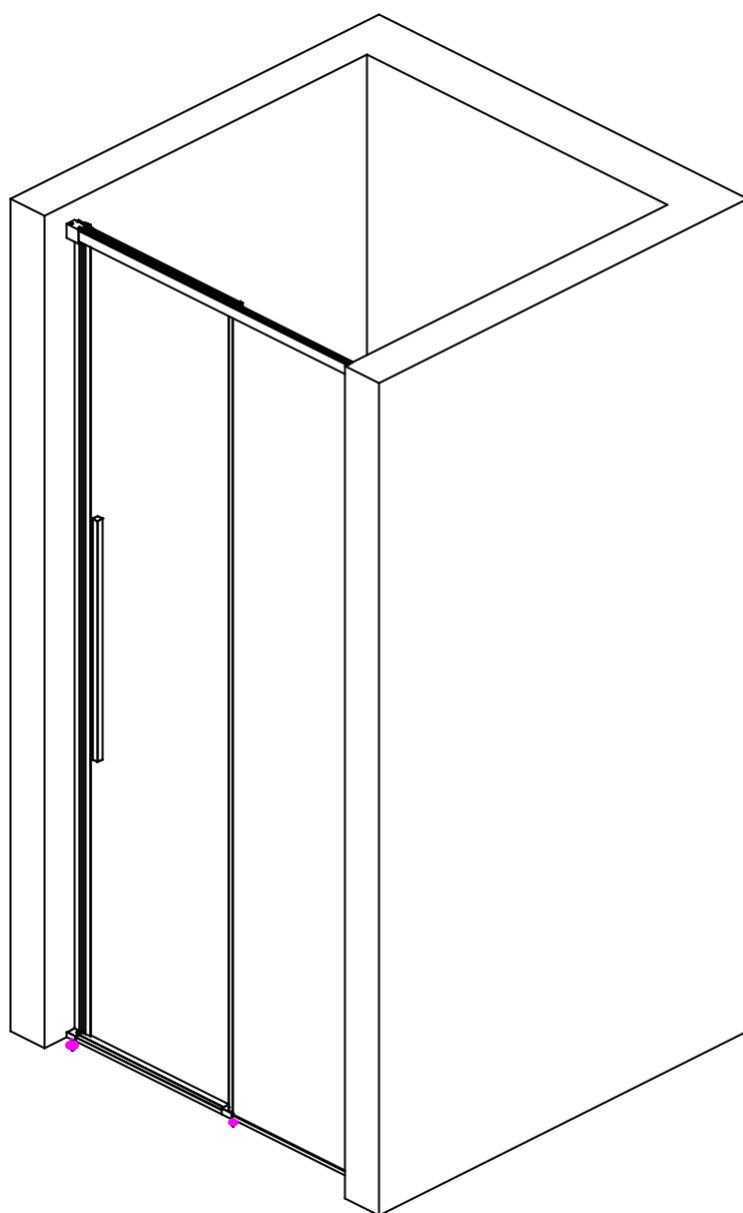

## SPRCHOVÉ DVEŘE GOLD

## VAROVÁNÍ

Nepoužívejte sprchový kout prvních 24 hodin po instalaci, aby silikon mohl úplně zaschnout.

### Obecná informace

Před zahájením montáže zkontrolujte, zda jsou všechny prvky obsažené v návodu obsaženy v obalu a zda nejsou poškozené. V případě poškození nebo chybějících položek kontaktujte neprodleně prodejce.

### UPOZORNĚNÍ: NEINSTALUJTE POŠKOZENÉ KOMPONENTY

a) před zahájením montáže si prosím přečtěte pokyny a zkontrolujte, zda máte požadované nástroje a součásti sprchového koutu. Následujte instrukce.

b) Při montáži nepoužívejte ostré nebo tvrdé nástroje, aby nedošlo k poškození skla. V případě potřeby použijte gumovou paličku.

POZNÁMKA: tvrzené sklo nelze upravovat.









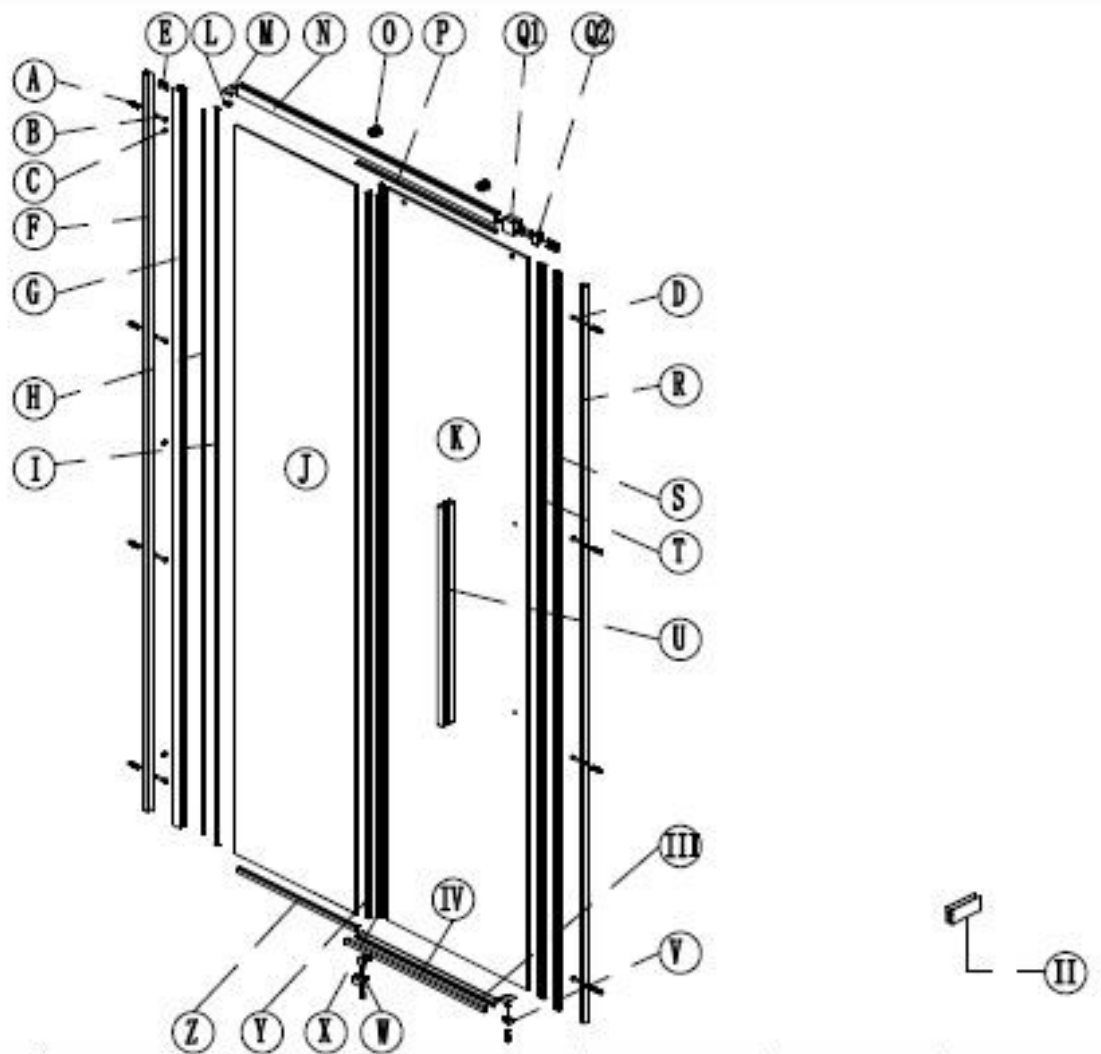



























Při vrtání otvorů do zdi buďte velmi opatrní, abyste se vyhnuli řezání trubek nebo kabelů.

POZNÁMKA: sprchový kout je těžký, může vyžadovat montáž dvěma osobami.

### Čištění a údržba:

Po použití by mělo být sklo omyto mýdlem a vodou. To je zvláště důležité, aby se zabránilo usazování vodního kamene nebo usazenin. Denní čištění lze provádět běžnými čisticími prostředky a měkkým hadříkem. Nedoporučuje se používat prostředky na bázi acetonu a amoniaku, stejně jako ostré houbičky. Vyhněte se prosím kontaktu s vysoce korozivními chemikáliemi, jako jsou rozpouštědla nebo odstraňovače nátěru.

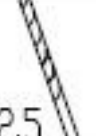

 X12	 ST4. 2x32 X8	 ST3. 5x9. 5 X3	 ST4. 2x32 X4	 ST3. 9x32 X2	 X1	 X1	 X1
 X1	 X1	 X1	 X1	 X1	 X1	 X2	 X1
 X1	 X1	 X1	 X1	 X1	 X1	 X1	 X1
 X1	 X1	 X2	 X1	 X1			
							 Ø2.5
