

# JOTA

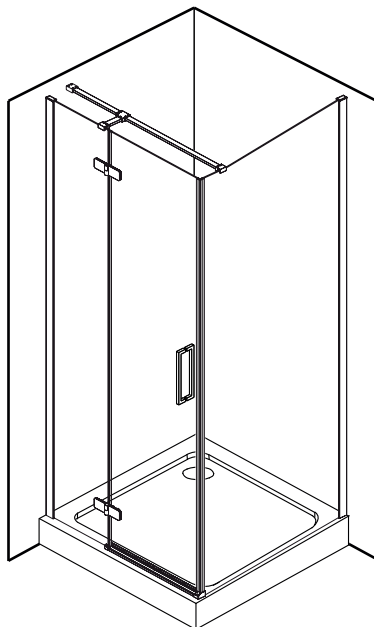

PL INSTRUKCJA MONTAŻU I EKSPLOATACJI

CZ NÁVOD NA MONTÁŽ A ÚDRŽBU

SK NÁVOD NA MONTÁŽ A ÚDRŽBU

EST PAIGALDUS- JA KASUTUSJUHEND

LT MONTAVIMO IR EKSPLOATAVIMO INSTRUKCIJA

LV MONTĀŽAS UN EKSPLUATĀCIJAS INSTRUKCIJA

DE MONTAGE- UND AUFBAUANLEITUNG

RO INSTRUCȚIUNI DE MONTAJ ȘI OPERARE

HU SZERELÉSI ÉS ÜZEMELTETÉSI ÚTMUTATÓ

UA ІНСТРУКЦІЯ З МОНТАЖУ І ЕКСПЛУАТАЦІЇ

BY ІНСТРУКЦЫЯ ПА МАНТАЖЫ І ЭКСПЛУАТАЦЫІ

RU ИНСТРУКЦИЯ ПО МОНТАЖУ И ЭКСПЛУАТАЦИИ

EN INSTRUCTIONS FOR ASSEMBLY AND USE

FR INSTALLATION ET UTILISATION - MODE

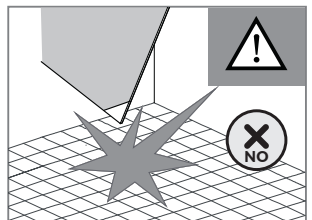
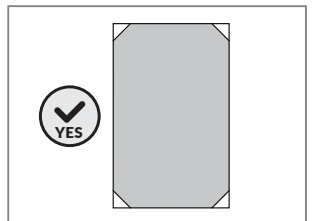
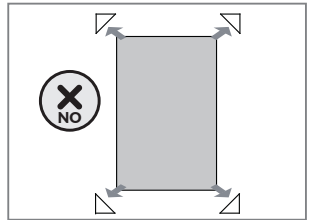
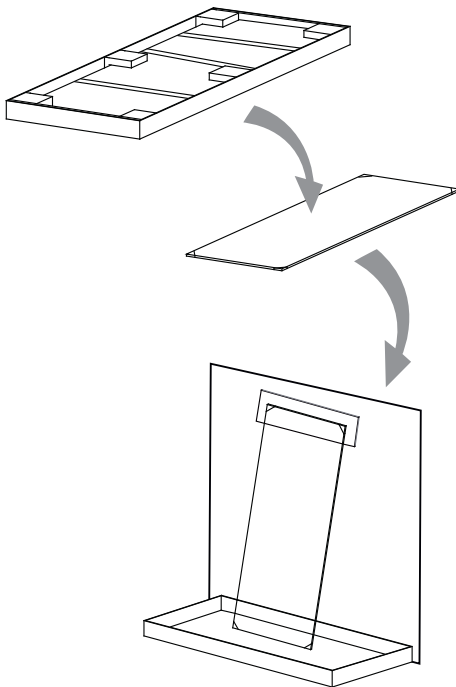
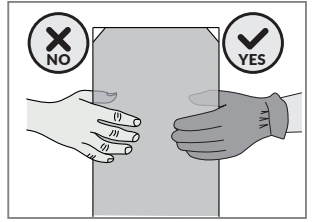
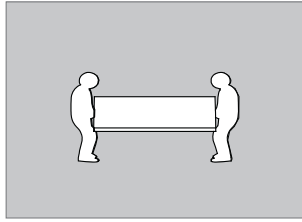
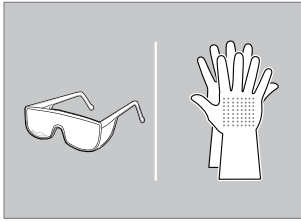
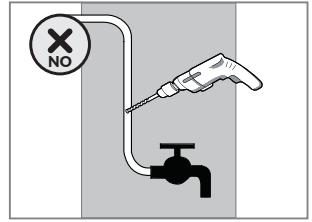
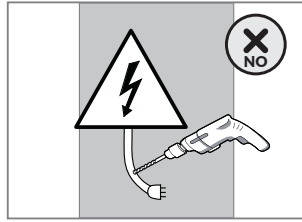
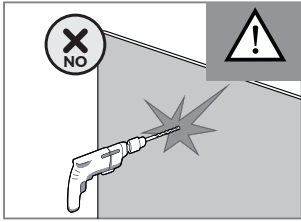

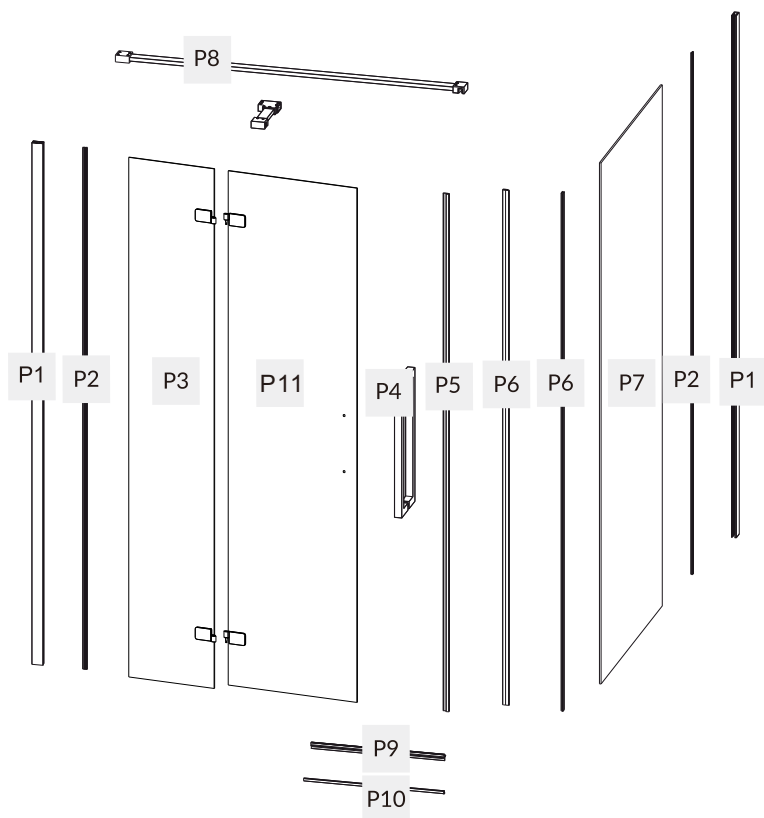

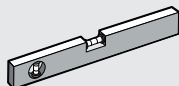
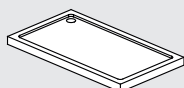
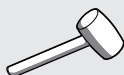
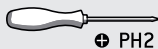
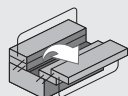
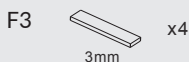
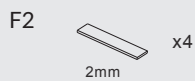
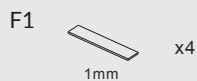
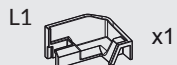
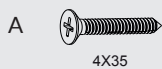
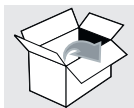



1.

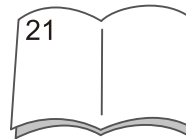
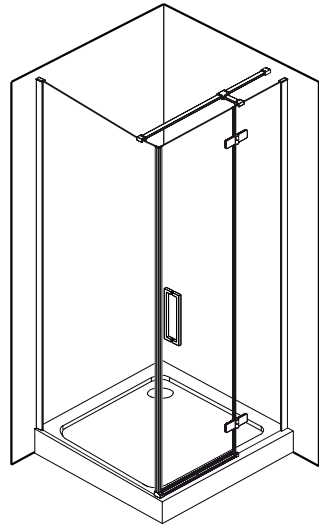
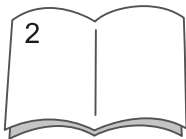
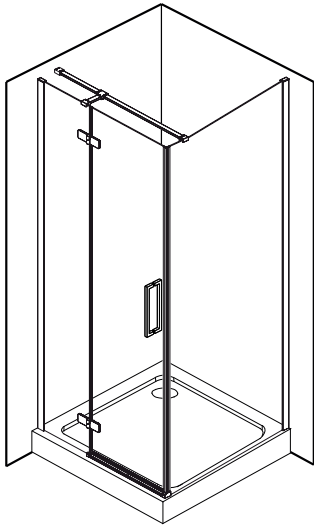

## 2.

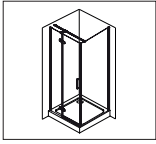

| SIZE         | X (mm)  | Y (mm)  |
|--------------|---------|---------|
| 900X900X1950 | 890-900 | 890-900 |

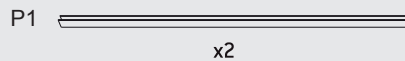
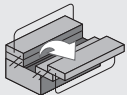
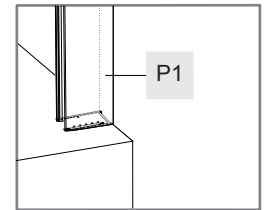
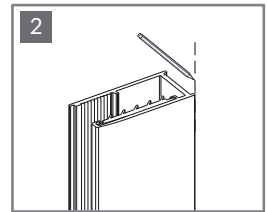
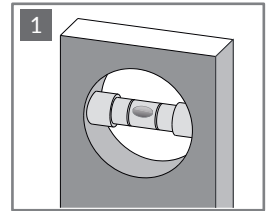
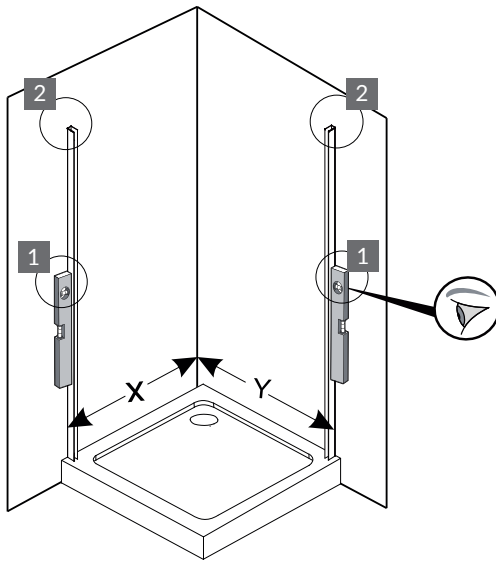

### 3.

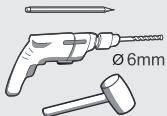
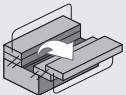
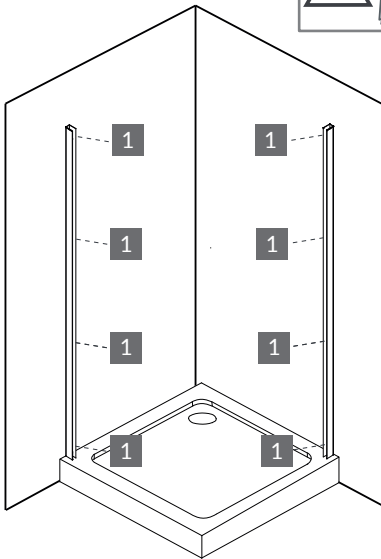
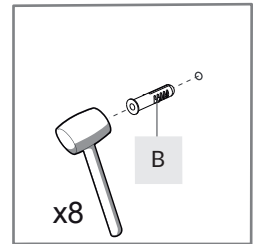
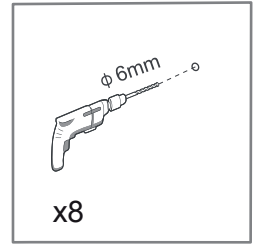
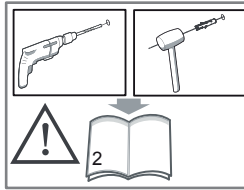
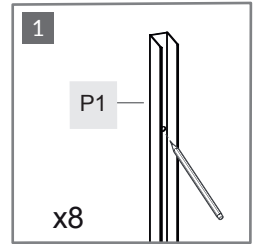
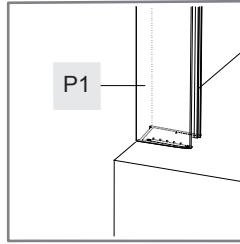
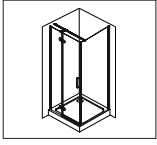

B



x8



4.

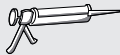
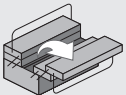
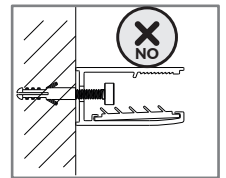
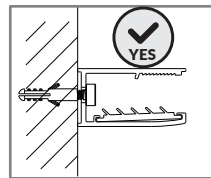
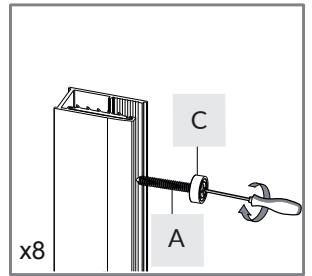
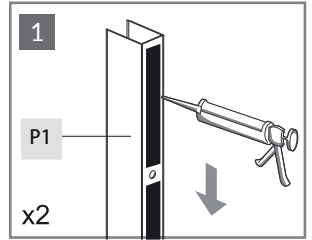
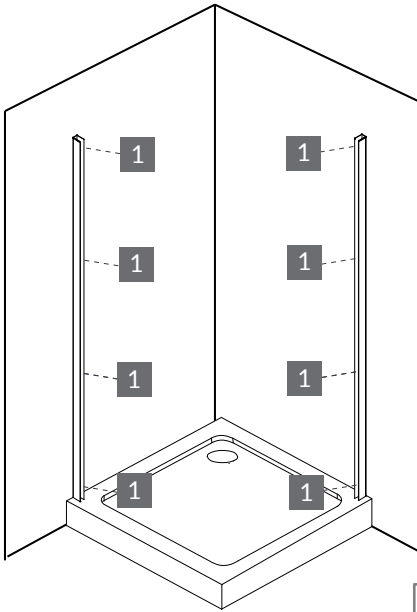
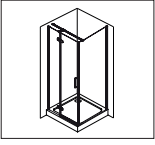

P1



x2

C



x8

A



4x35 x8



# 5.

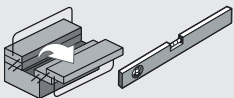
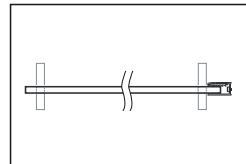
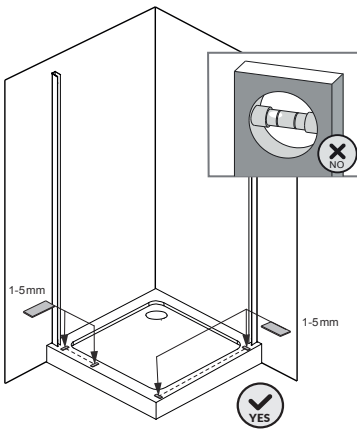
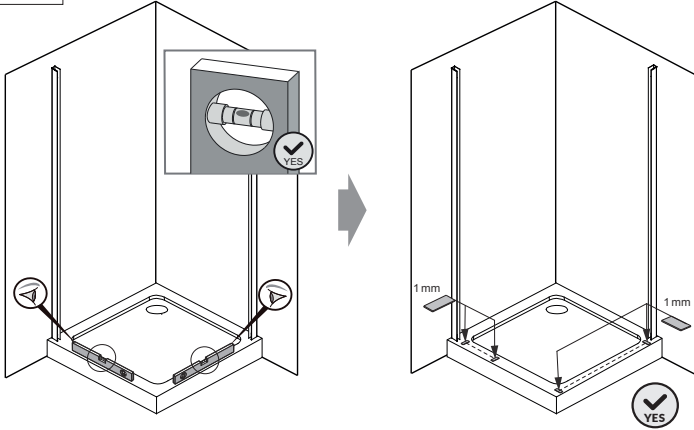
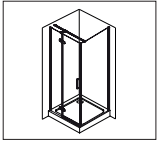

F1



x4

F2



x4

F3



x4



# 6.

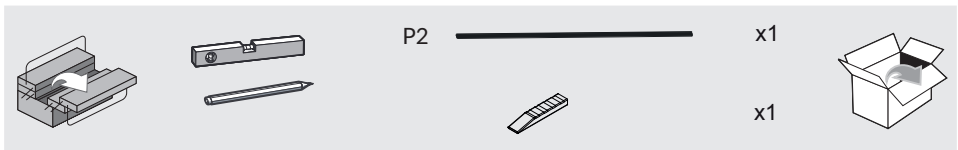
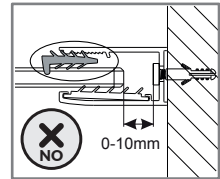
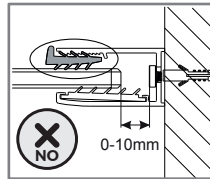
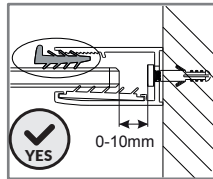
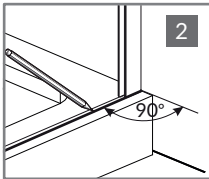
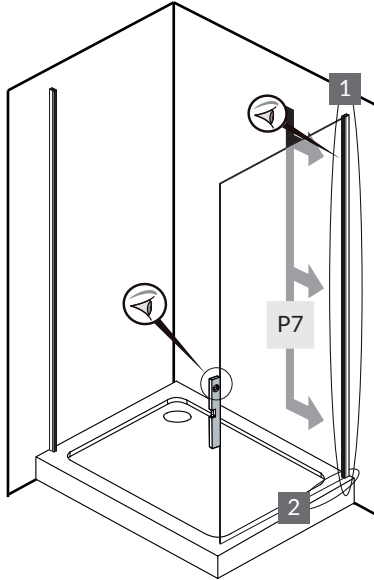
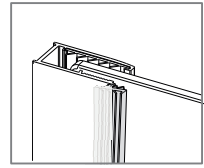
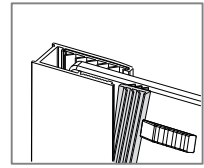
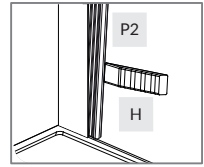
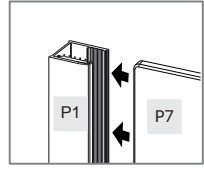
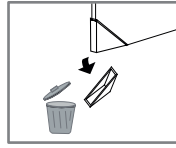
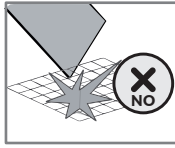
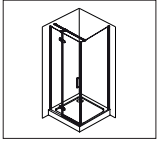

# 7.

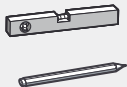
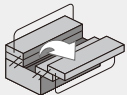
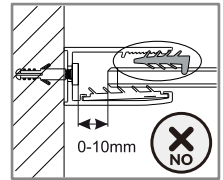
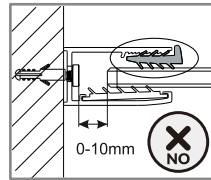
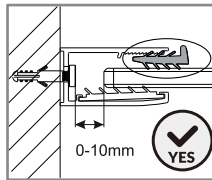
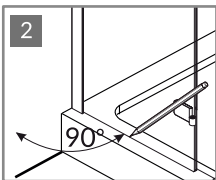
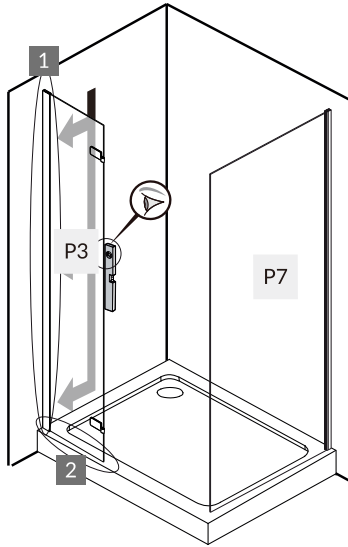
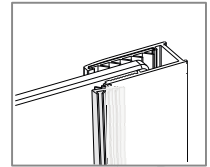
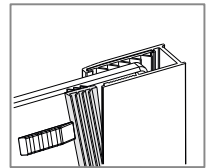
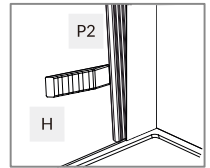
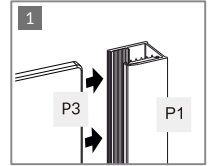
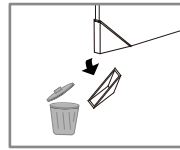
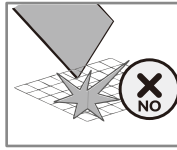
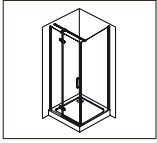

P2 ————— x1

H ————— x1



8.

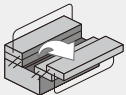
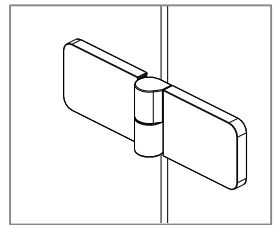
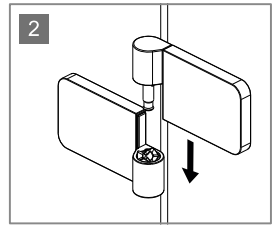
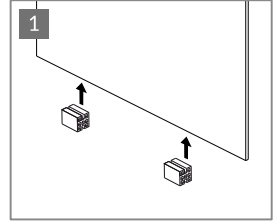
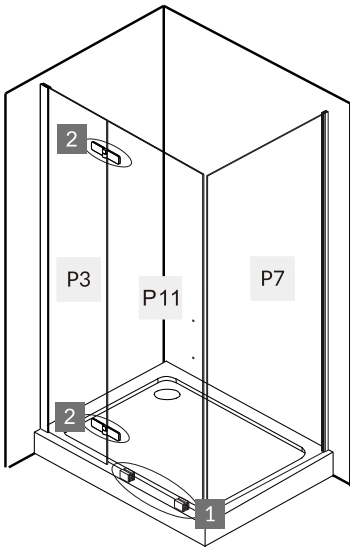
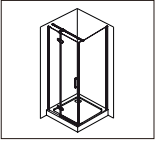

P11



x1

N2



x2





9.

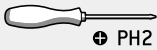
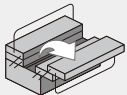
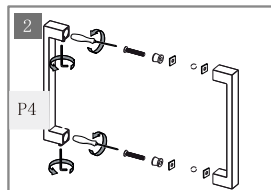
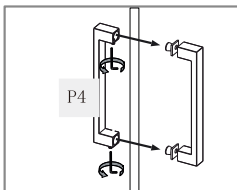
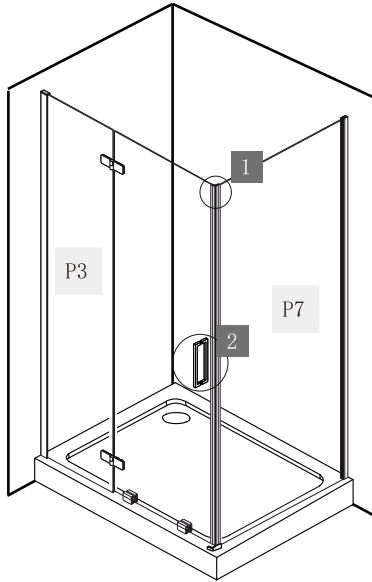
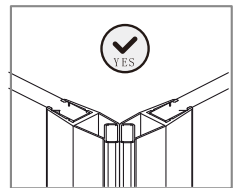
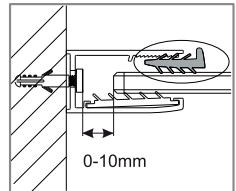
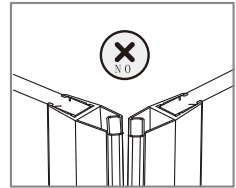
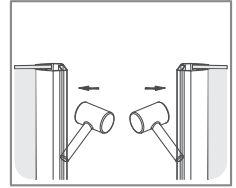
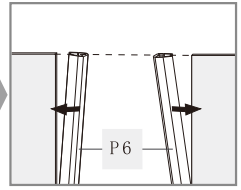
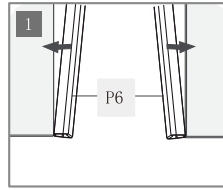
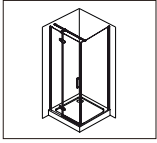

P6



x2

P4



x1



10.

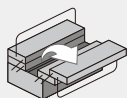
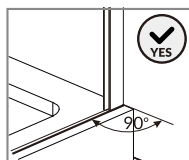
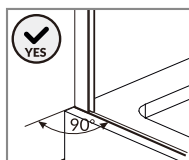
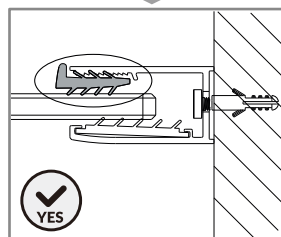
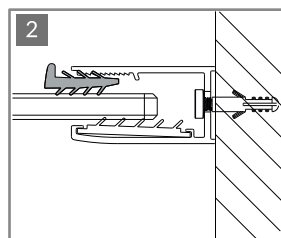
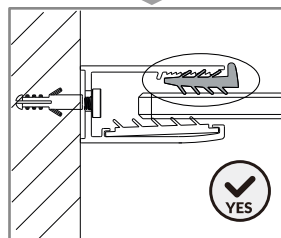
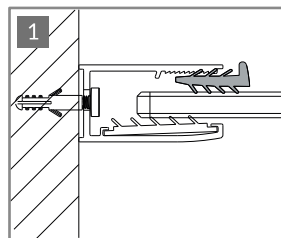
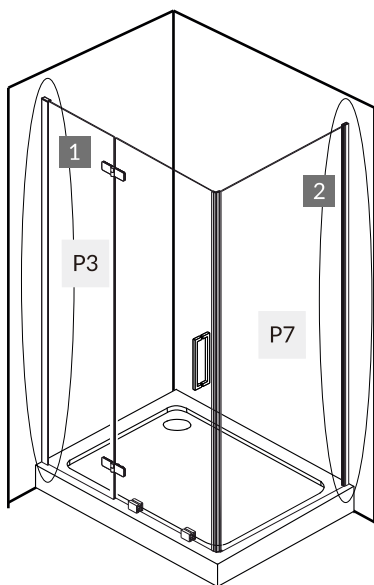
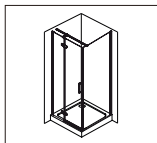

H



x1



# 11.

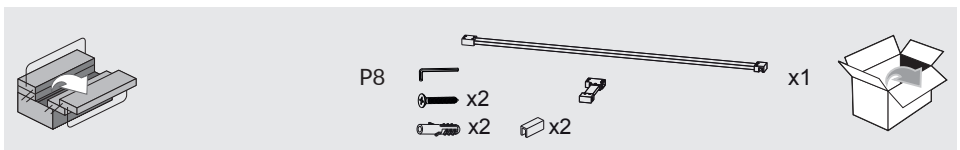
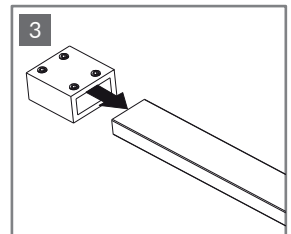
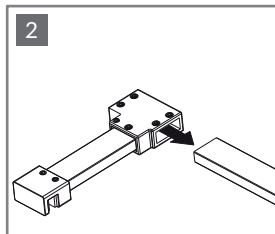
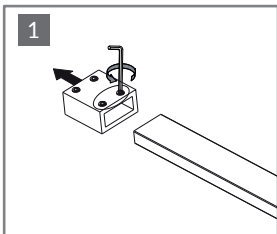
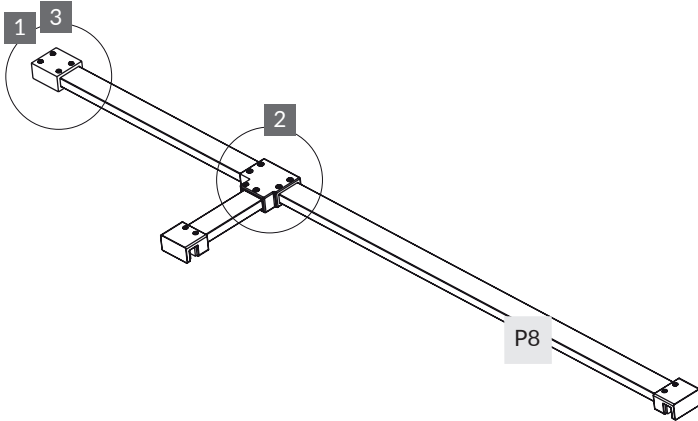
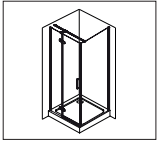

# 12.

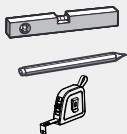
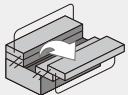
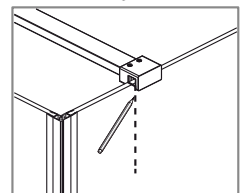
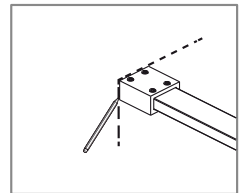
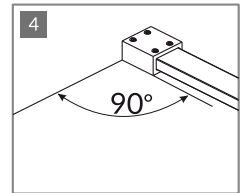
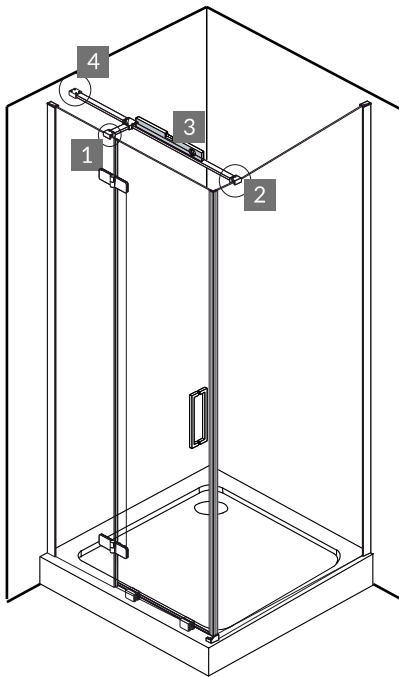
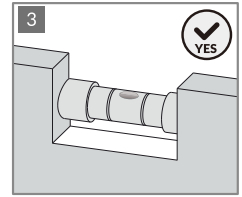
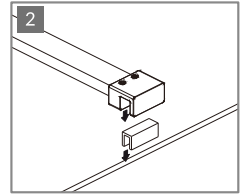
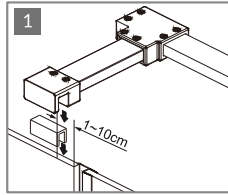
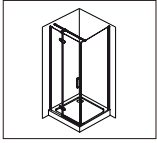

P8



x1

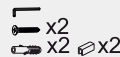

# 13.

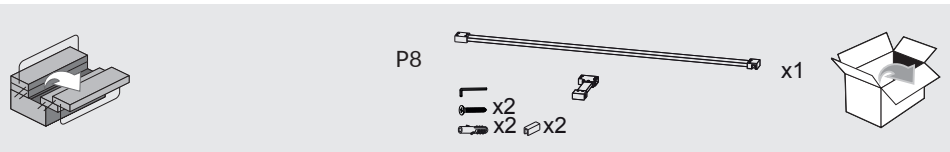
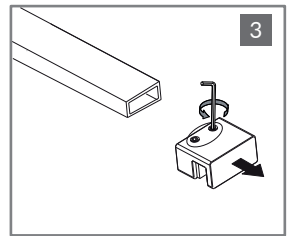
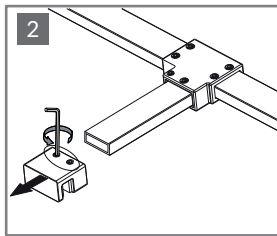
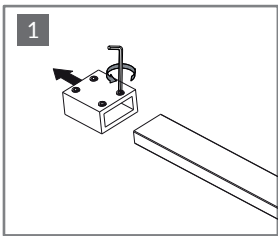
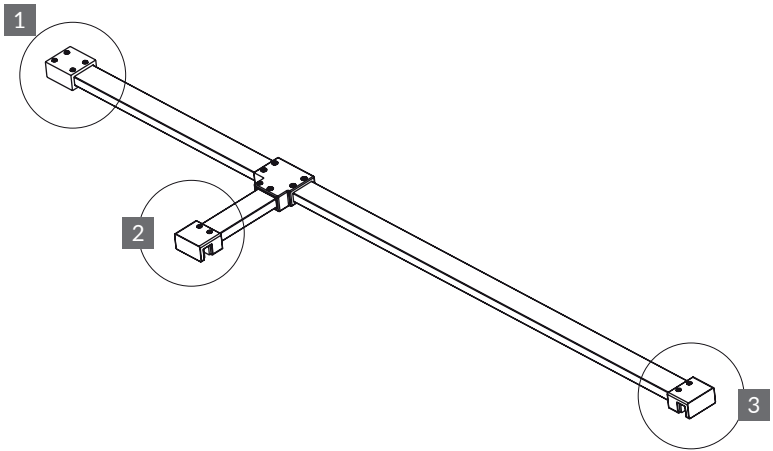
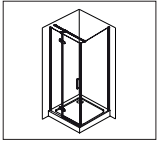

# 14.

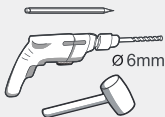
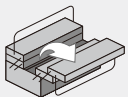
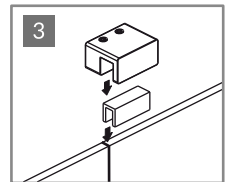
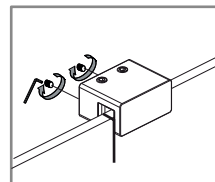
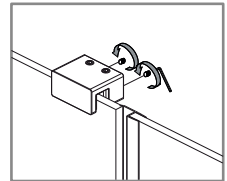
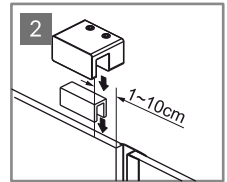
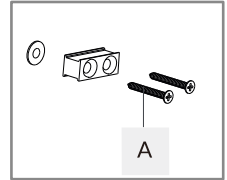
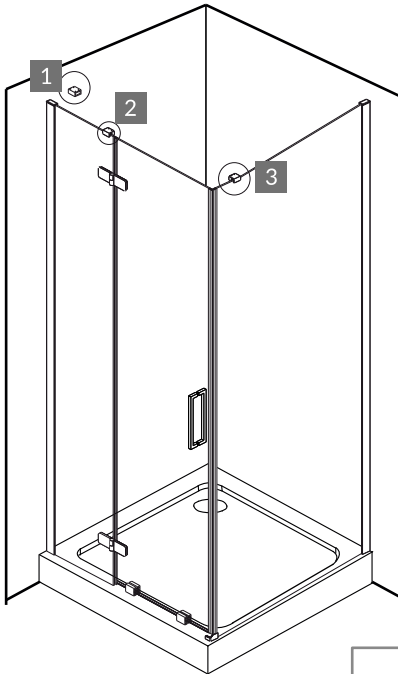
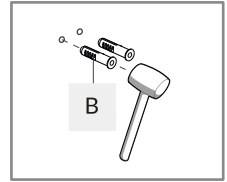
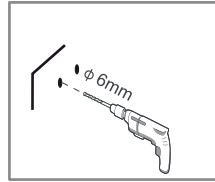
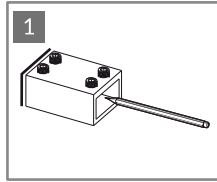
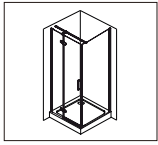

A  4x35 x2

B  x2



# 15.

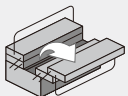
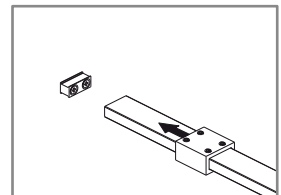
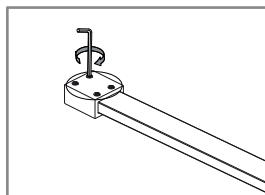
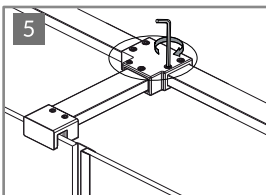
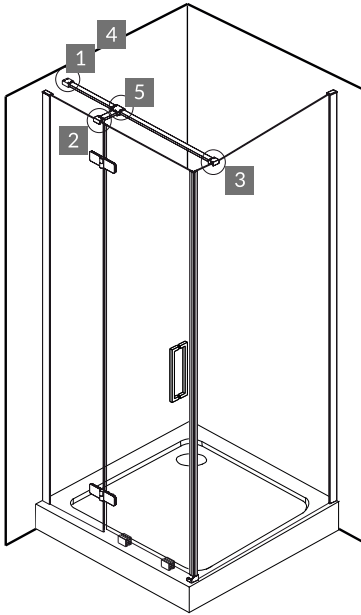
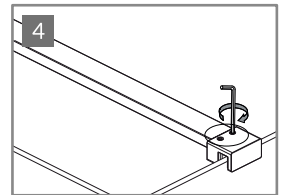
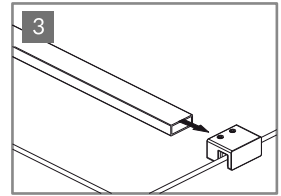
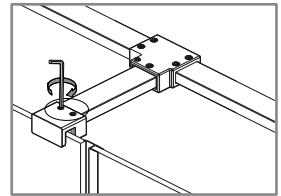
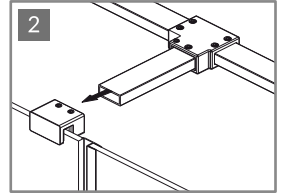
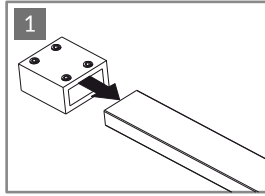
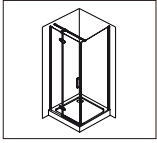

P8



x1



x2



16.

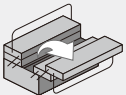
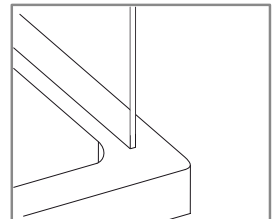
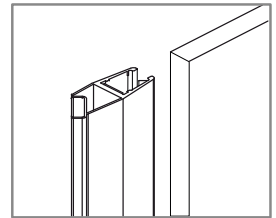
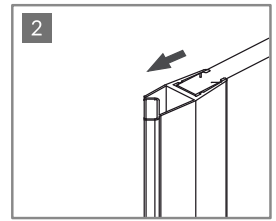
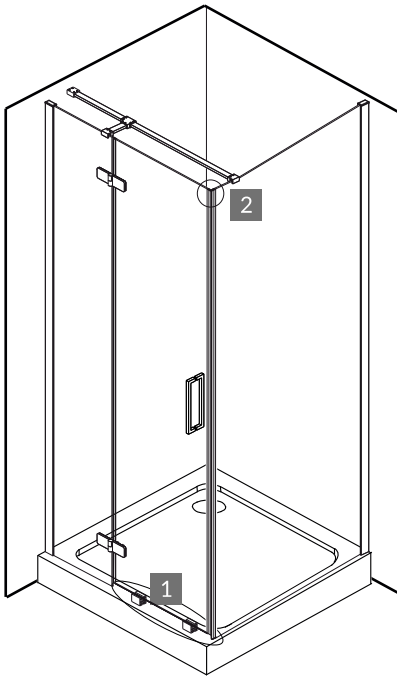
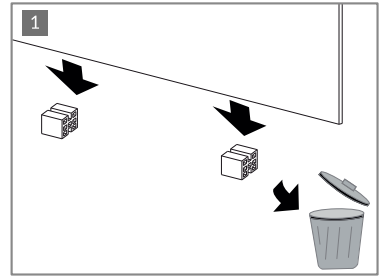
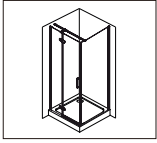

N2



x2





17.

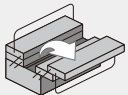
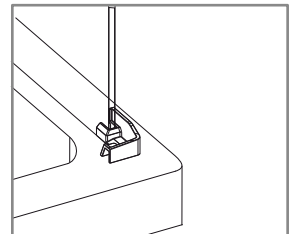
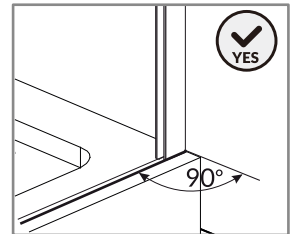
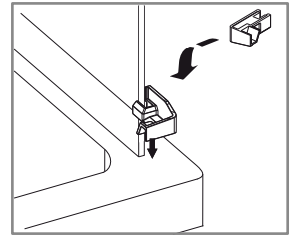
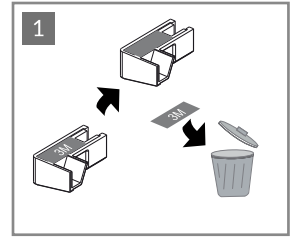
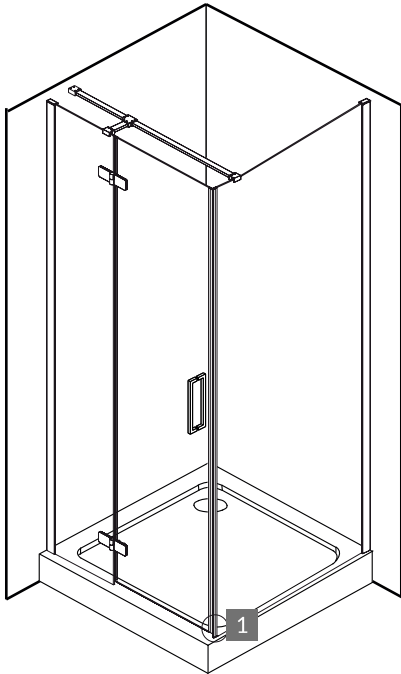
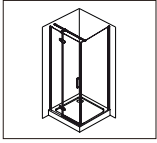

L1



x1



18.

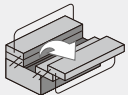
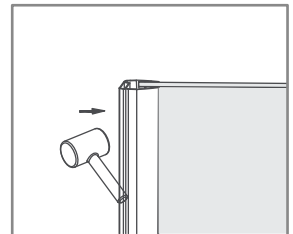
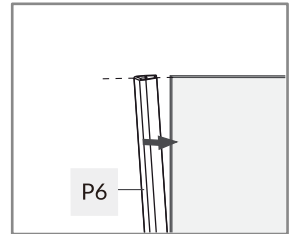
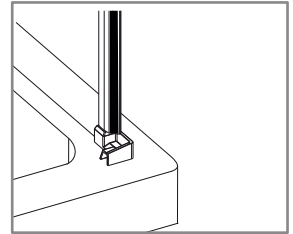
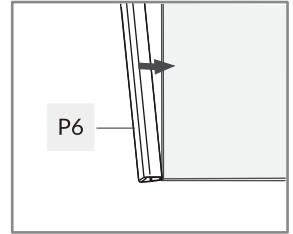
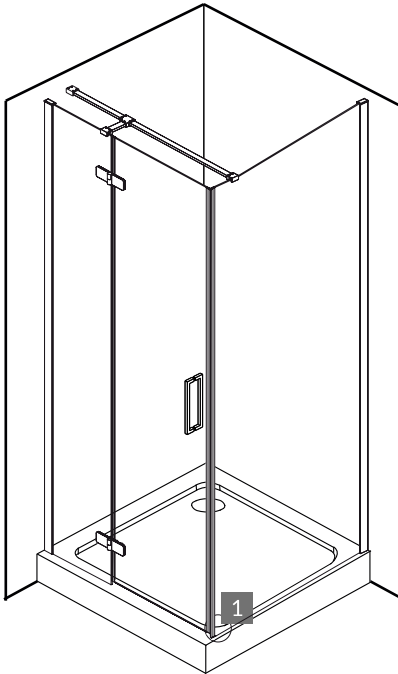
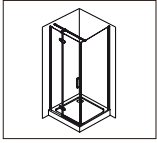

P6



x1



19.

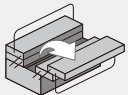
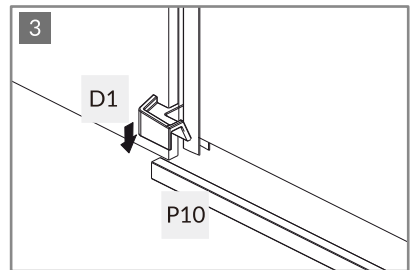
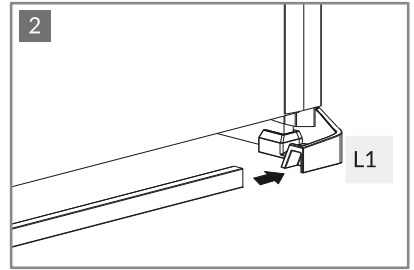
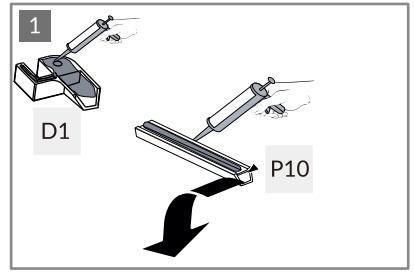
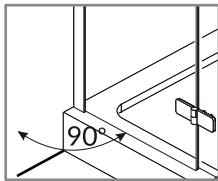
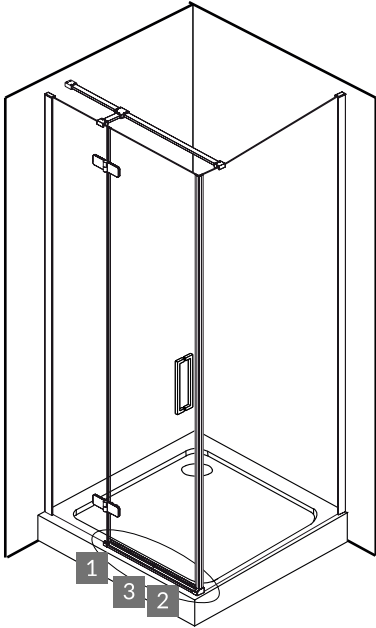
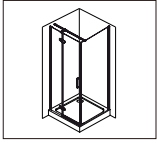

P10



x1

D1



x1



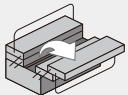
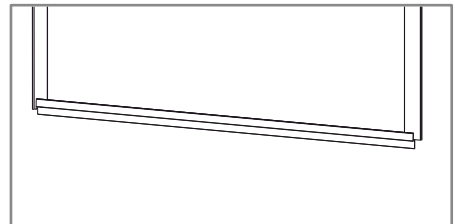
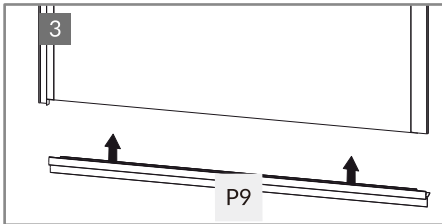
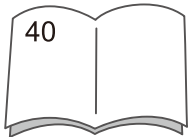
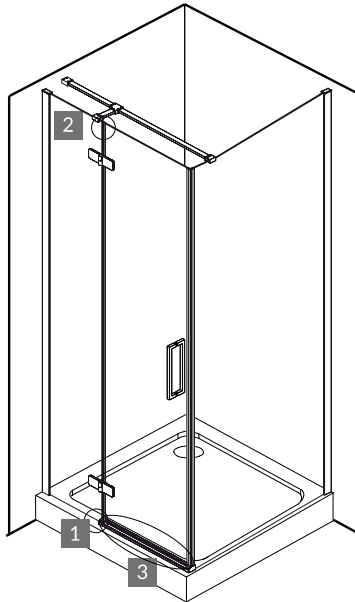
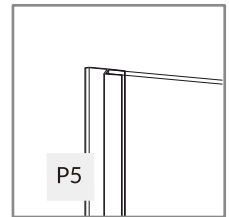
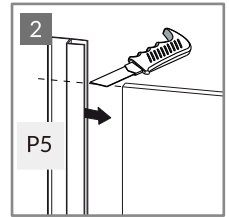
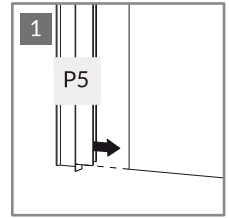
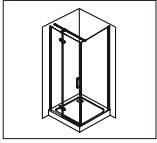

P5  x1

P9  x1



21.

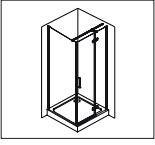

| SIZE         | X (mm)  | Y (mm)  |
|--------------|---------|---------|
| 900X900X1950 | 890-900 | 890-900 |

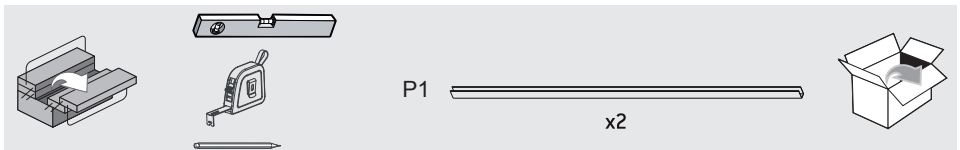
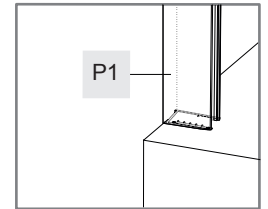
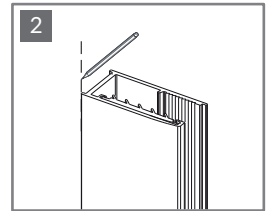
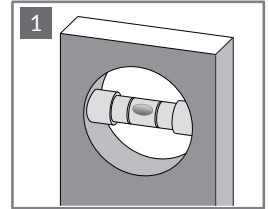
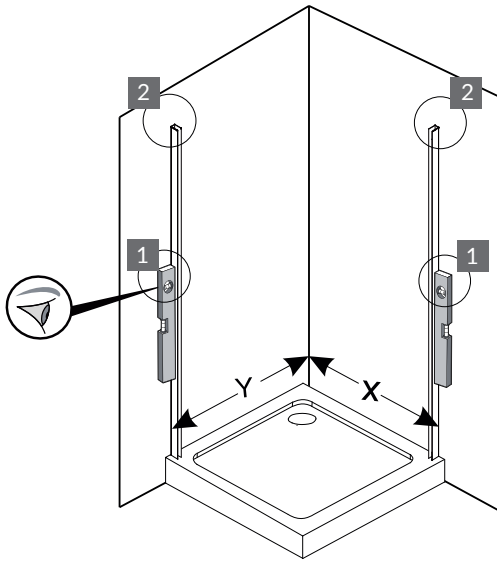

22.

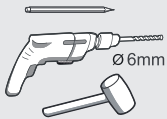
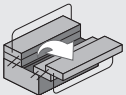
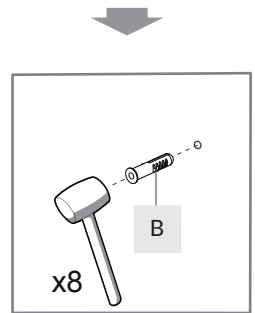
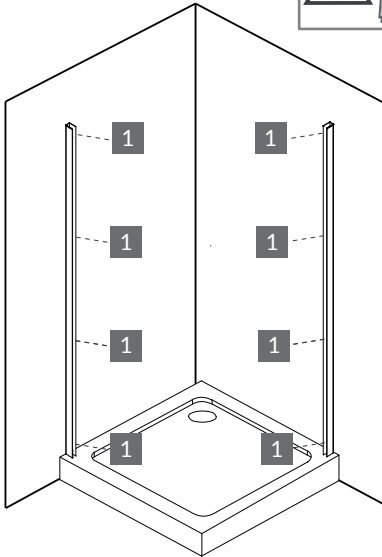
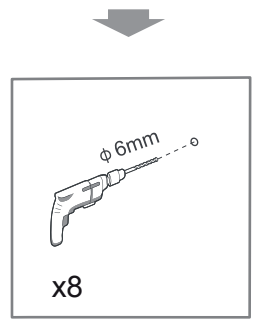
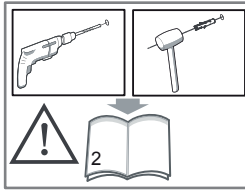
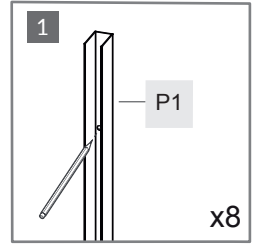
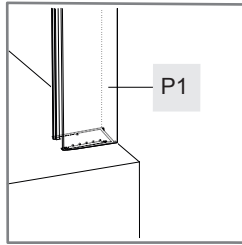
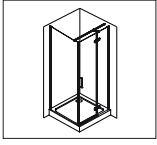

B



x8



23.

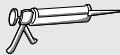
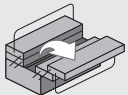
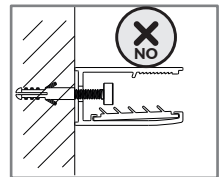
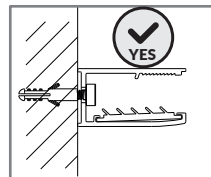
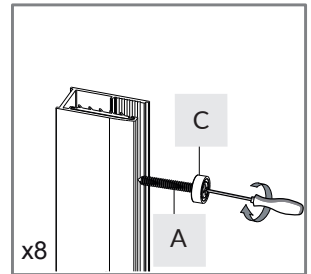
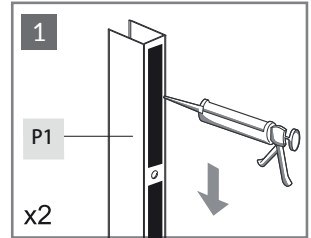
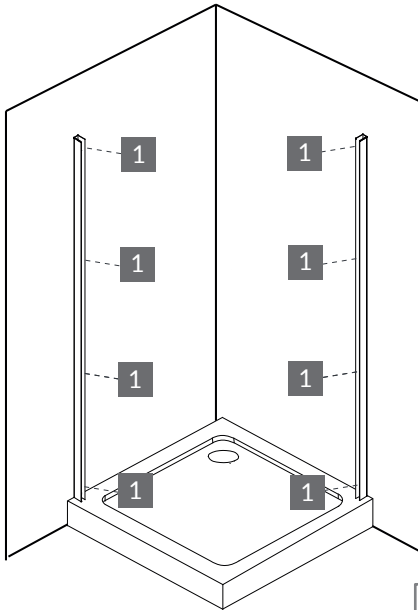
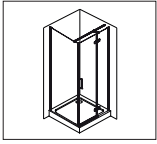

P1



x2



PH2

C



x8

A



4x35

x8



24.

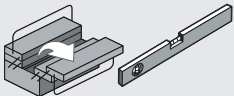
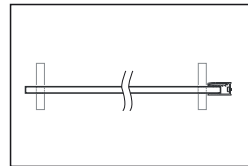
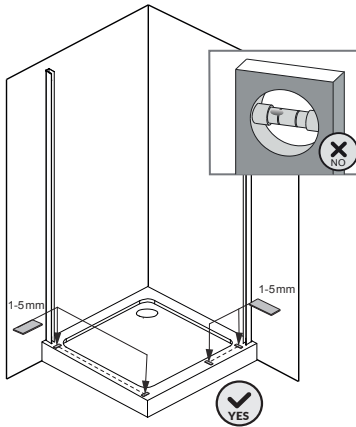
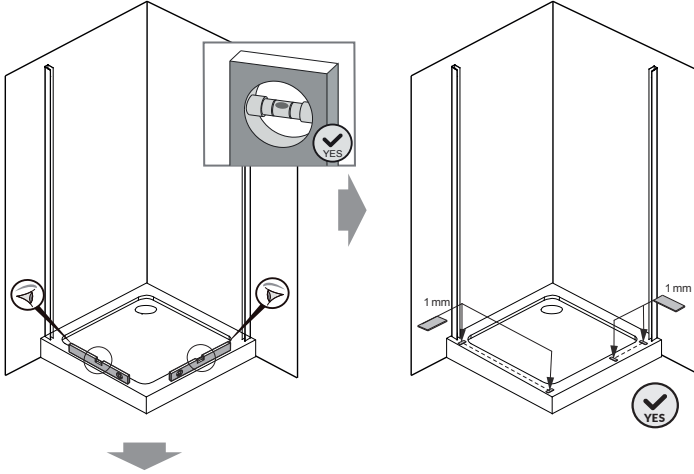
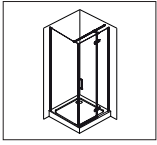

F1



x4

F2



x4

F3



x4





25.

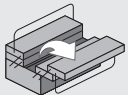
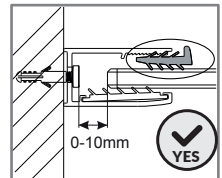
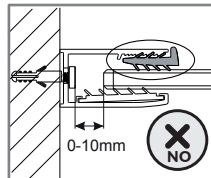
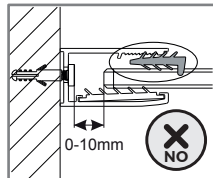
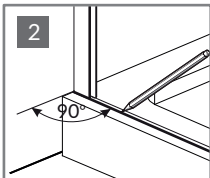
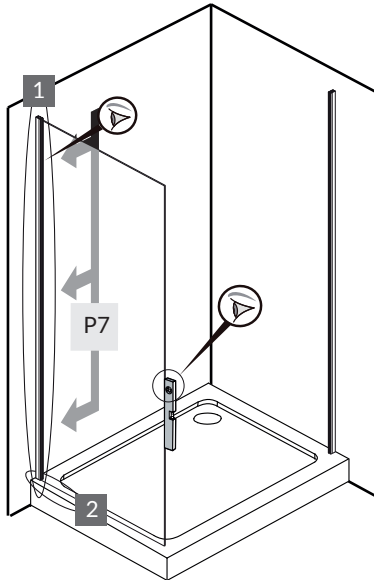
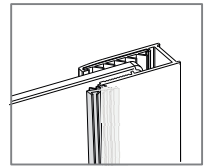
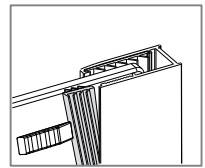
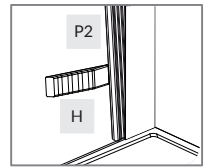
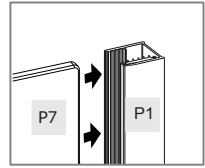
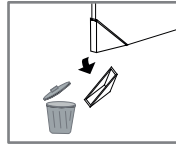
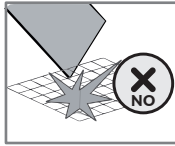
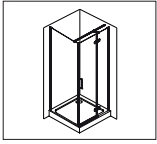

P2 —————

x1



x1



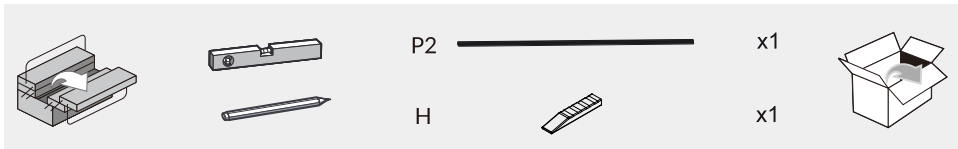
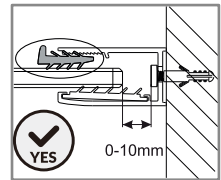
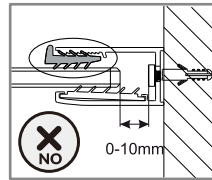
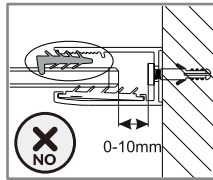
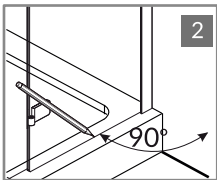
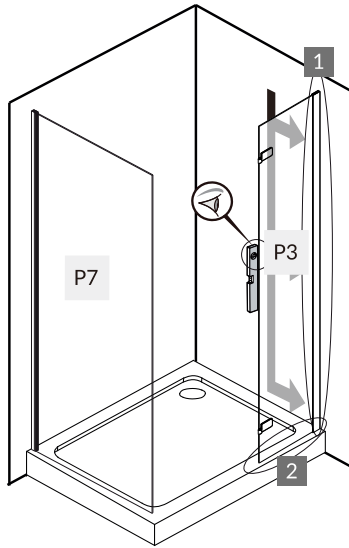
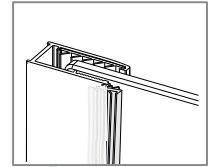
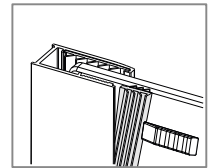
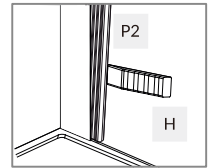
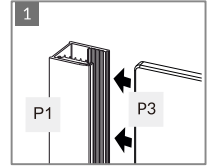
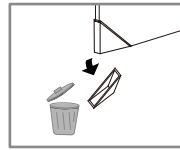
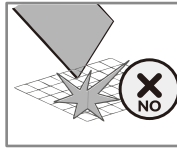
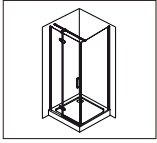

27.

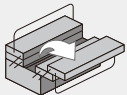
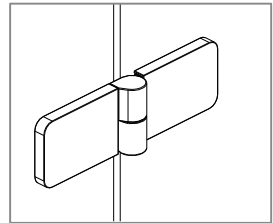
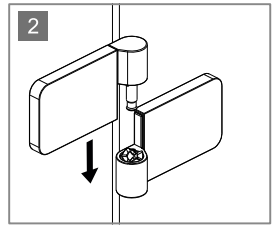
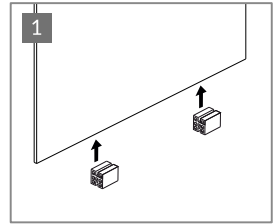
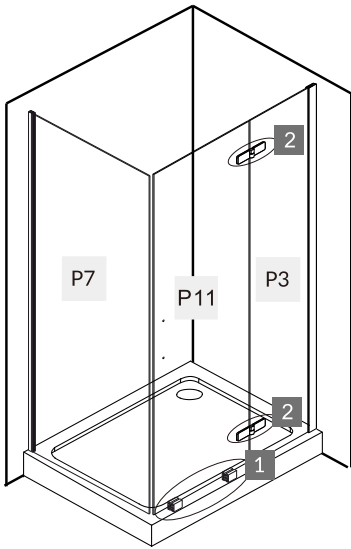
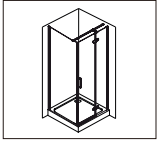

P11

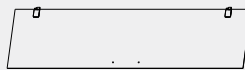

x1

N2



x2



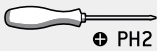
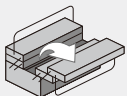
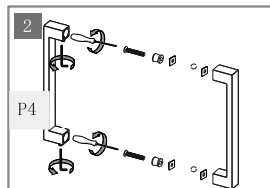
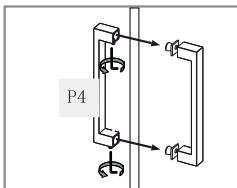
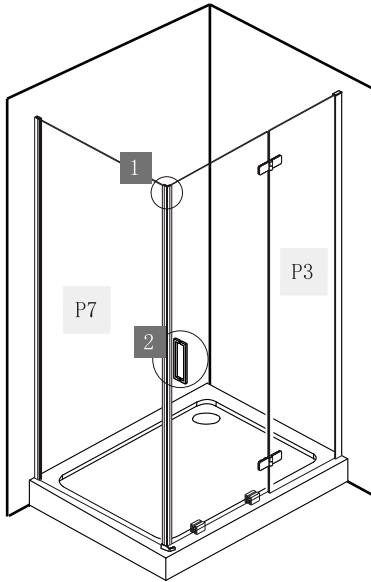
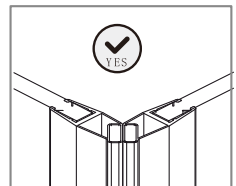
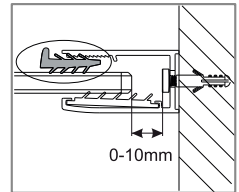
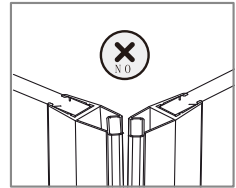
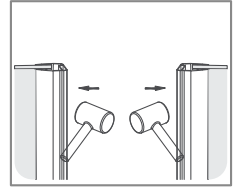
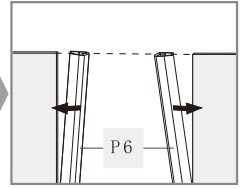
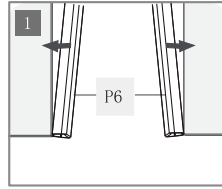
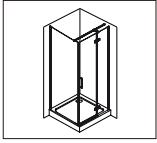

P6 ————— x2

P4 ————— x1



29.

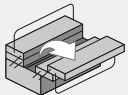
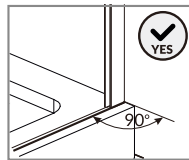
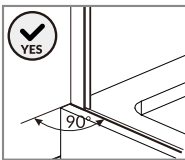
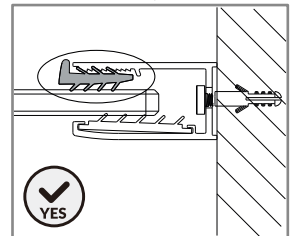
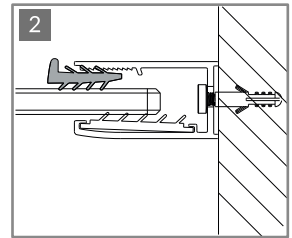
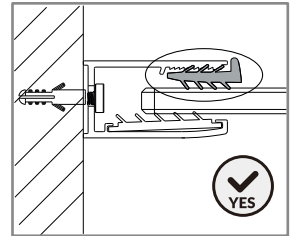
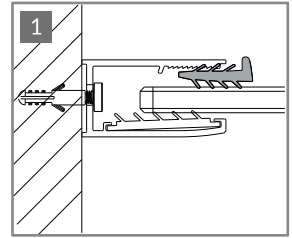
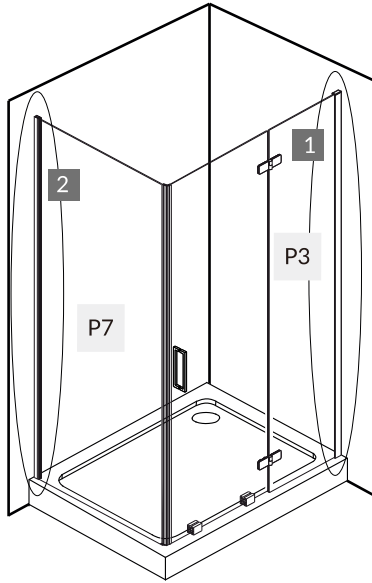
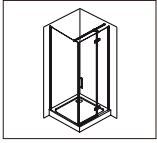

H







x1

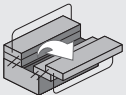
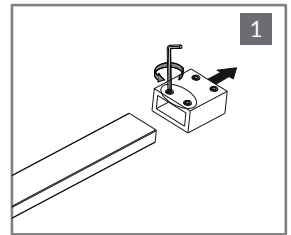
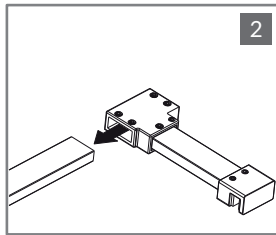
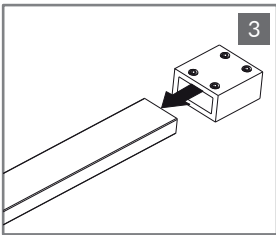
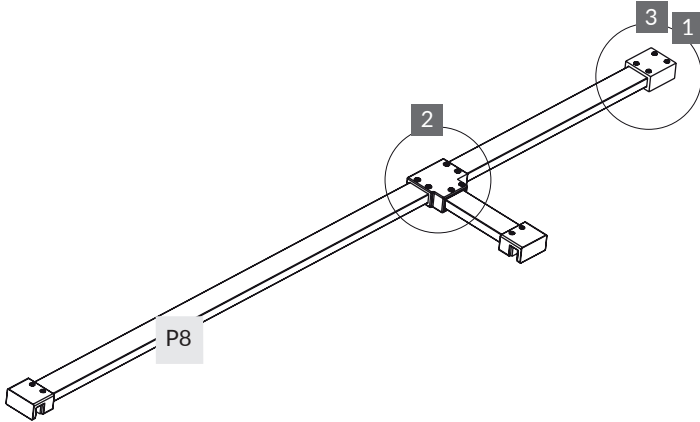
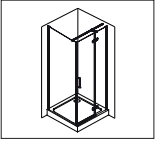

30.



- P8
-  x2
-  x2
-  x2
-  x2
-  x1



31.

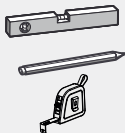
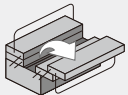
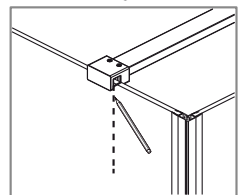
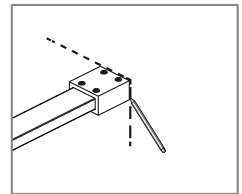
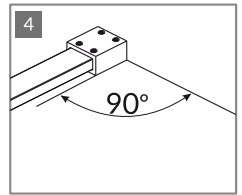
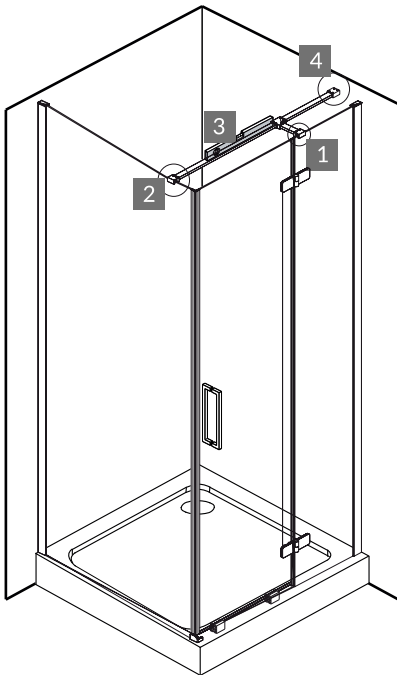
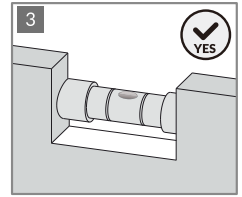
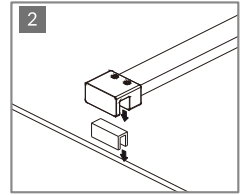
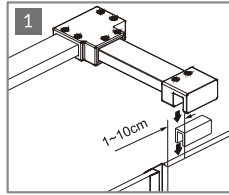
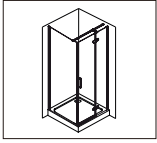

P8



x1

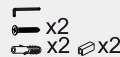

x2

x2 x2



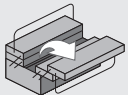
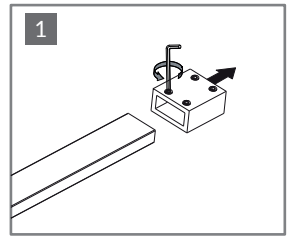
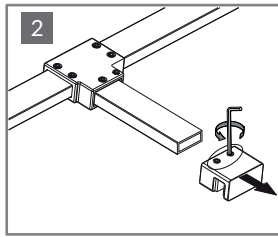
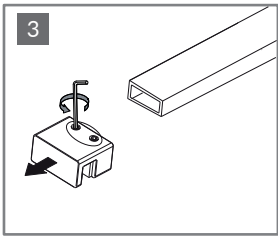
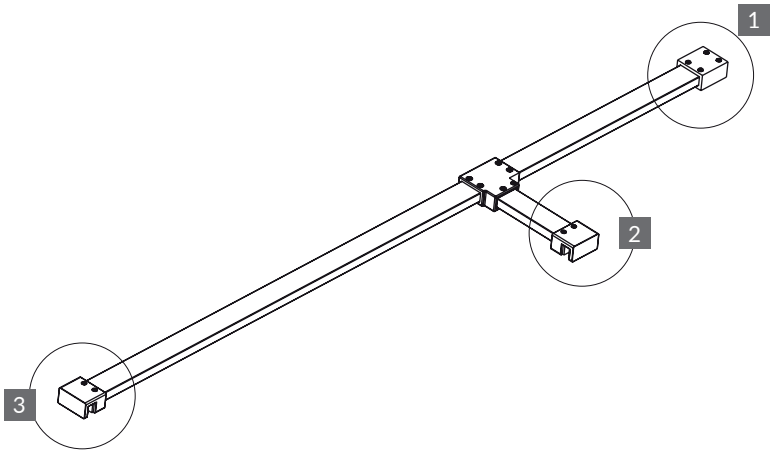
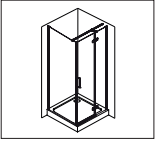

P8



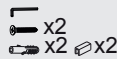

x1



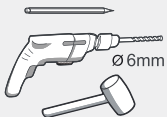
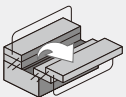
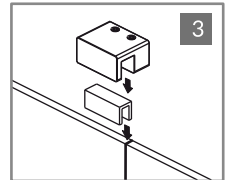
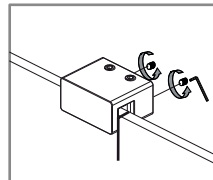
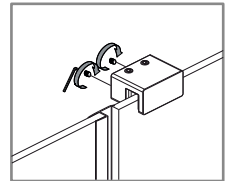
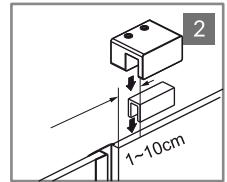
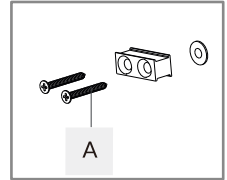
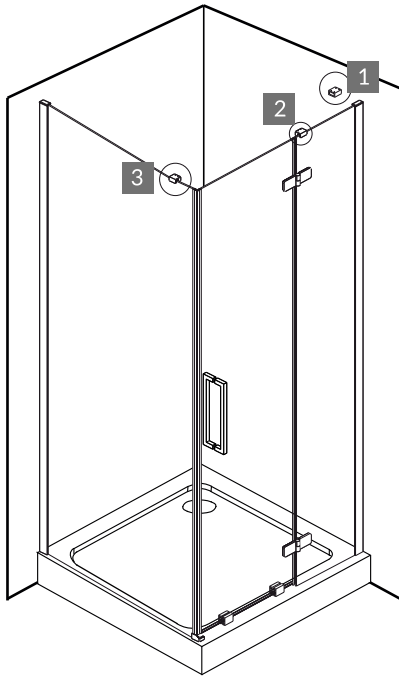
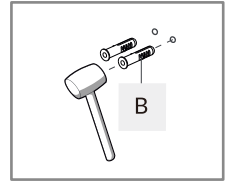
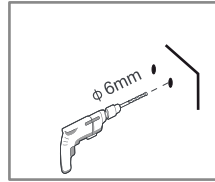
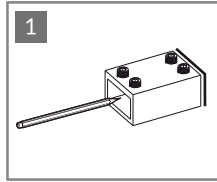
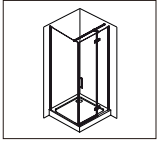

33.





A  x2

B  x2

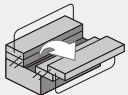
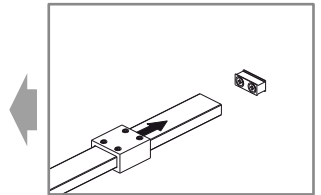
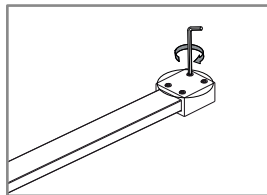
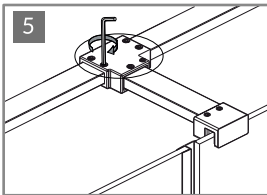
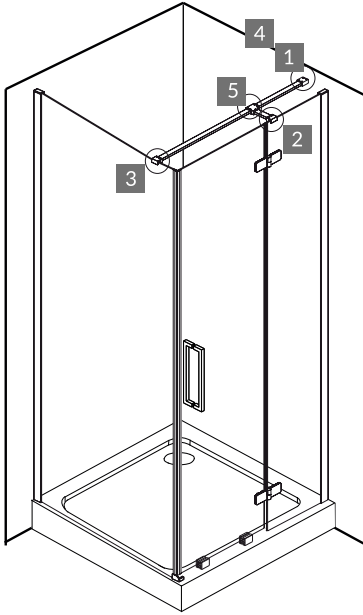
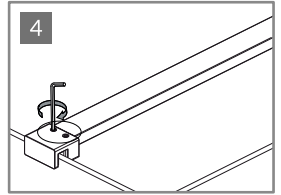
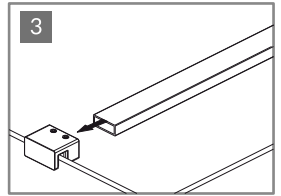
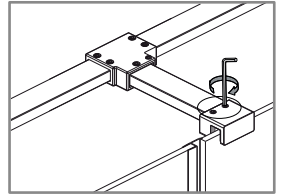
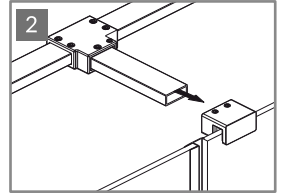
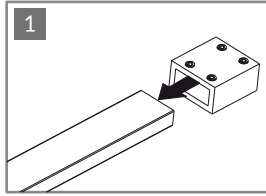
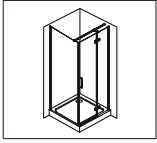



- P8  x1
-  x2
-  x2



35.

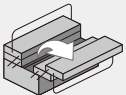
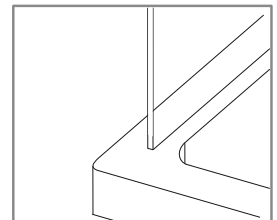
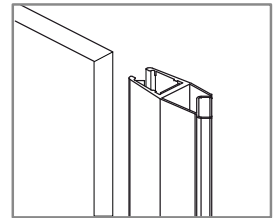
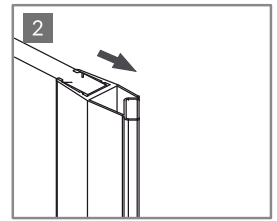
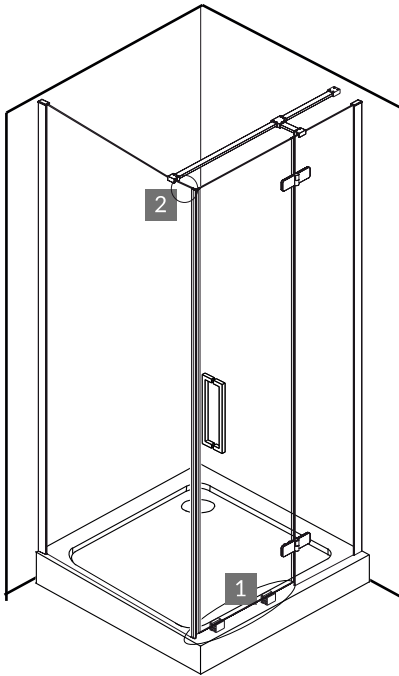
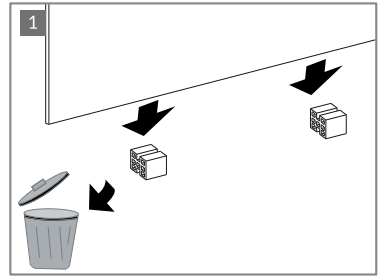
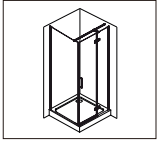

N2



x2



36.

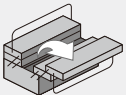
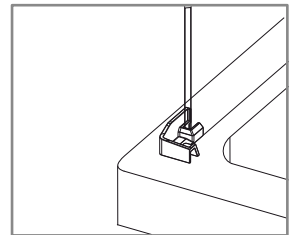
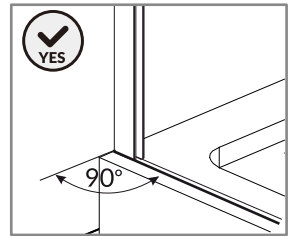
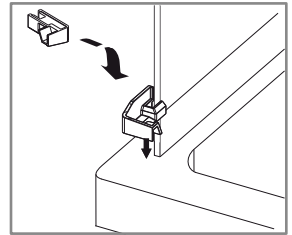
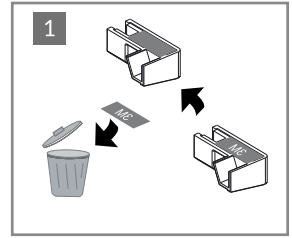
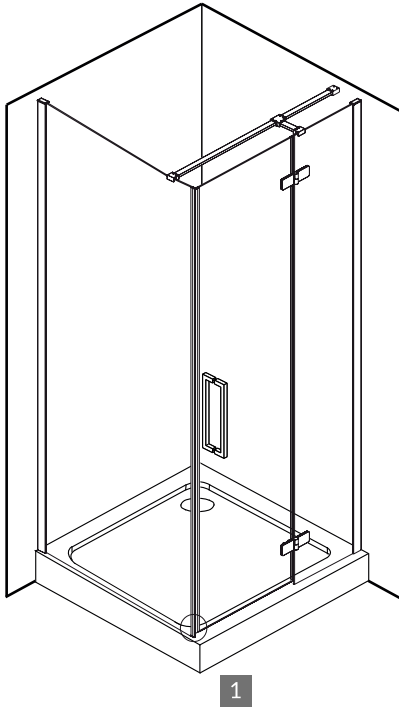
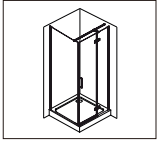

L2



x1



37.

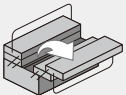
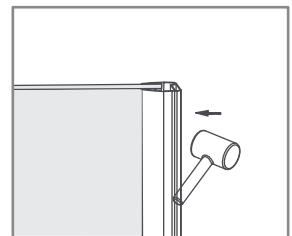
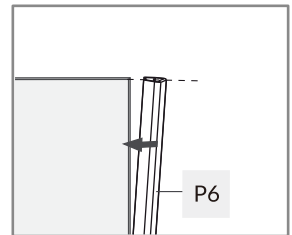
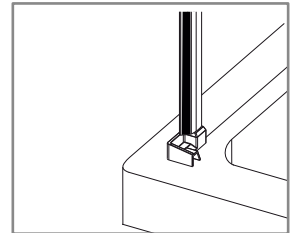
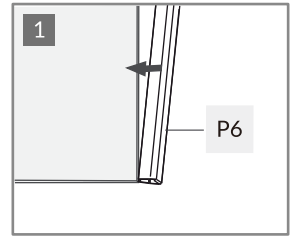
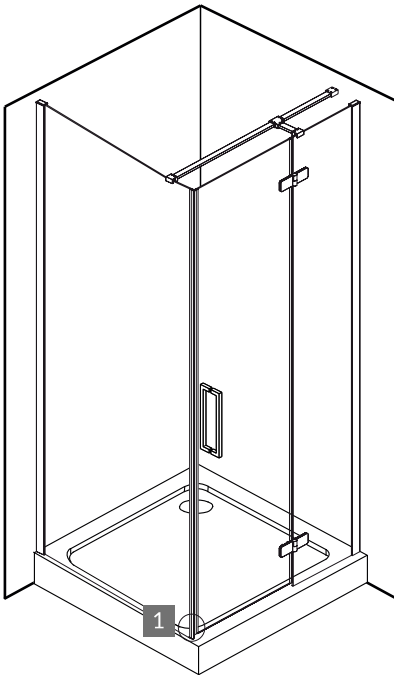
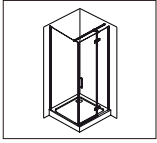

P6



x1



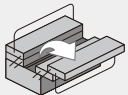
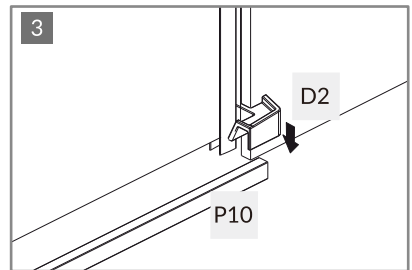
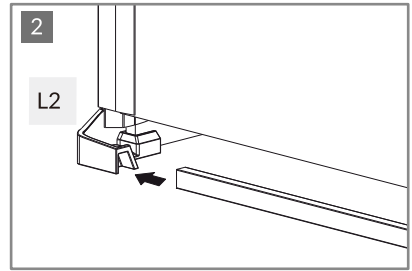
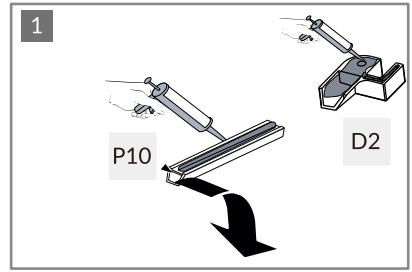
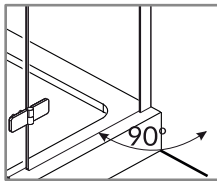
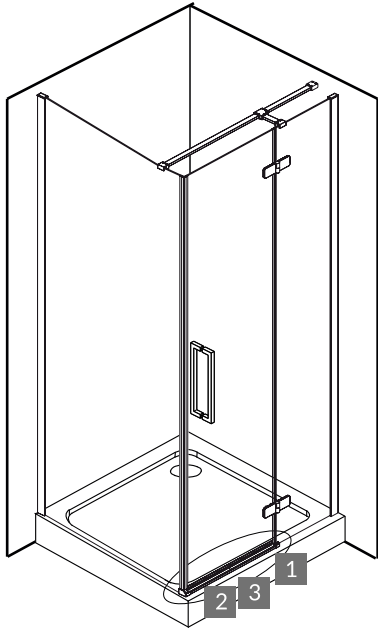
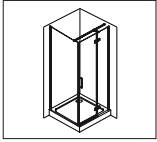

P10



x1

D2



x1



39.

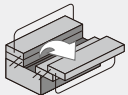
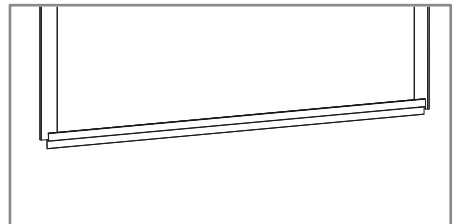
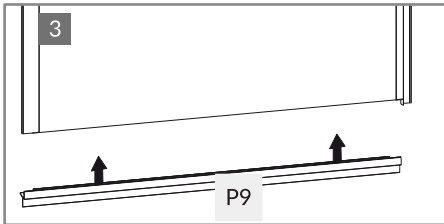
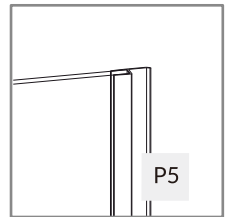
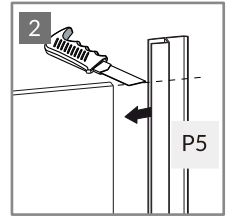
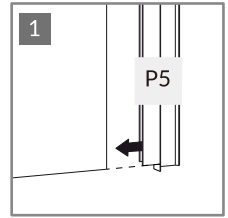
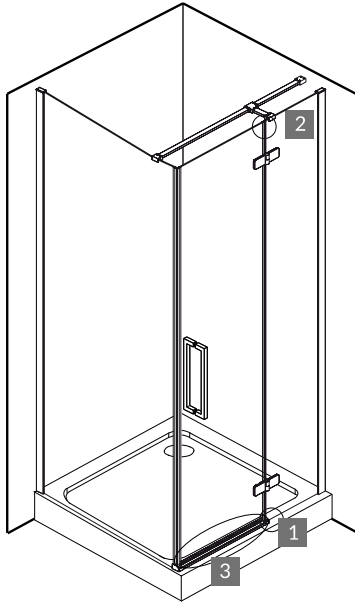
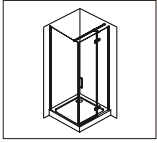

P5  x1

P9  x1



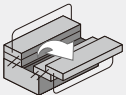
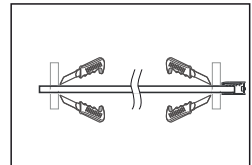
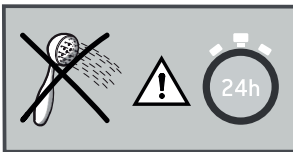
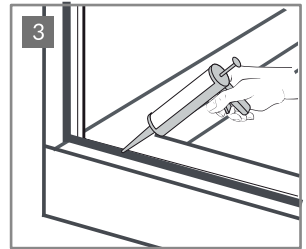
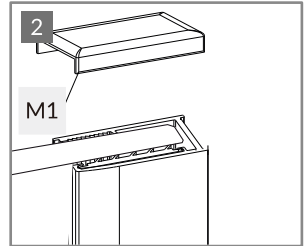
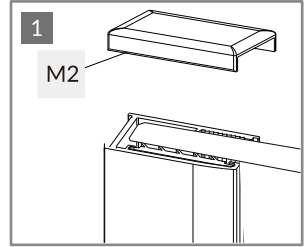
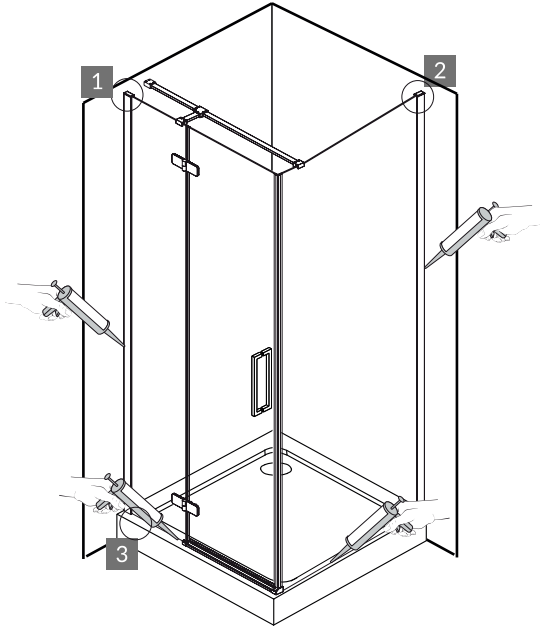
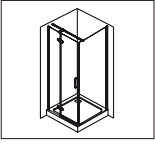

M1  x1

M2  x1







6.5<PH<7.5

