

JOTA

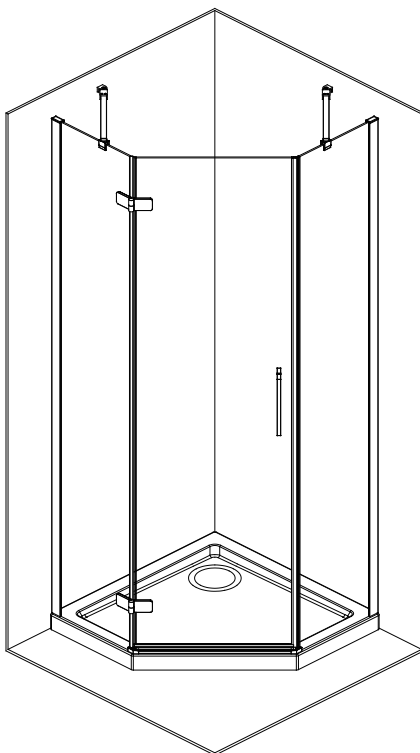

PL INSTRUKCJA MONTAŻU I EKSPLOATACJI
CZ NÁVOD NA MONTÁŽ A ÚDRŽBU
SK NÁVOD NA MONTÁŽ A ÚDRŽBU
EST PAIGALDUS- JA KASUTUSJUHEND
LT MONTAVIMO IR EKSPLOAVIMO INSTRUKCIJA
LV MONTĀŽAS UN EKSPLOATĀCIJAS INSTRUKCIJA
DE MONTAGE- UND AUFBAUANLEITUNG

RO INSTRUCȚIUNI DE MONTAJ ȘI OPERARE
HU SZERELÉSI ÉS ÜZEMELTETÉSI ÚTMUTATÓ
UA ІНСТРУКЦІЯ З МОНТАЖУ І ЕКСПЛУАТАЦІЇ
BY ІНСТРУКЦЫЯ ПА МАНТАЖУ І ЕКСПЛУАТАЦЫІ
RU ИНСТРУКЦИЯ ПО МОНТАЖУ И ЭКСПЛУАТАЦИИ
EN INSTRUCTIONS FOR ASSEMBLY AND USE
FR INSTALLATION ET UTILISATION - MODE

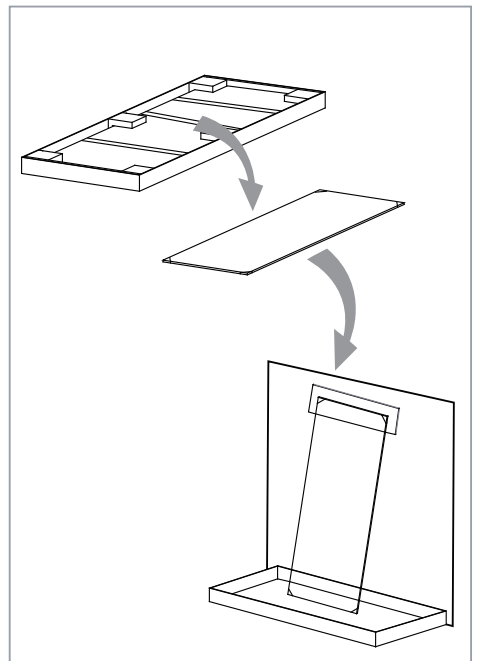
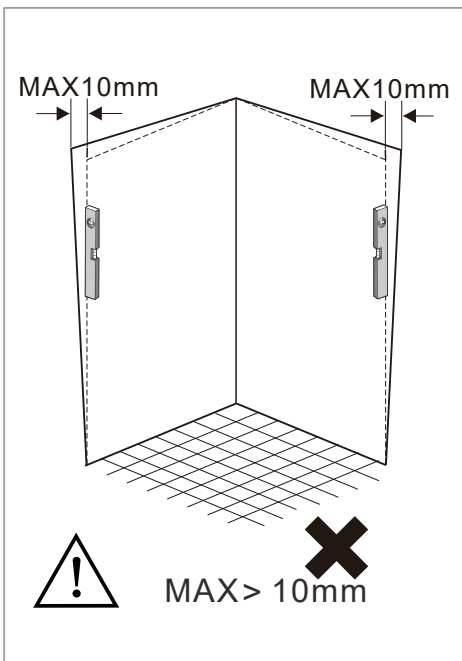
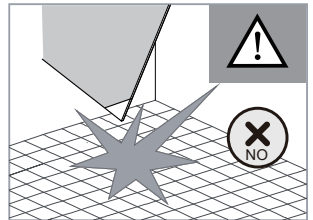
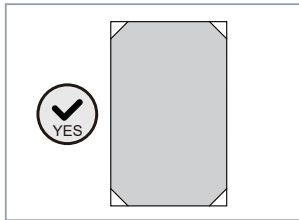
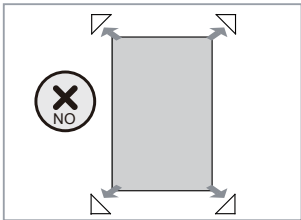
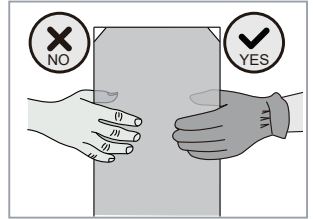
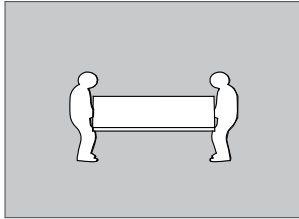
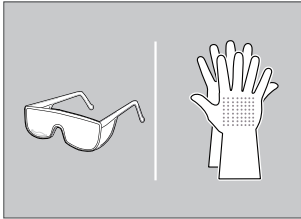
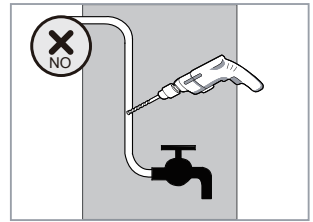
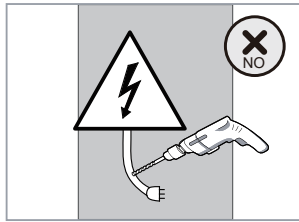
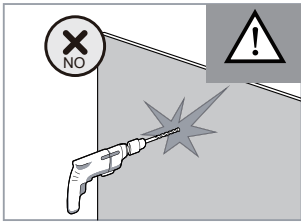

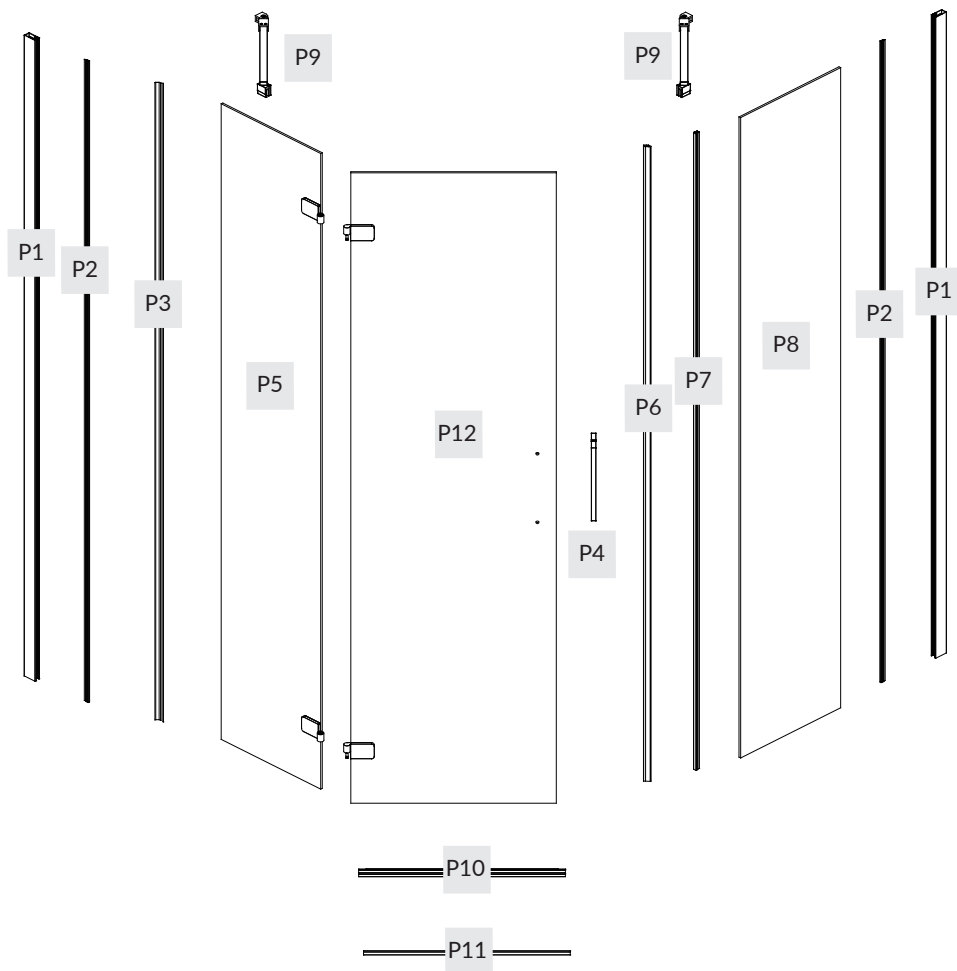

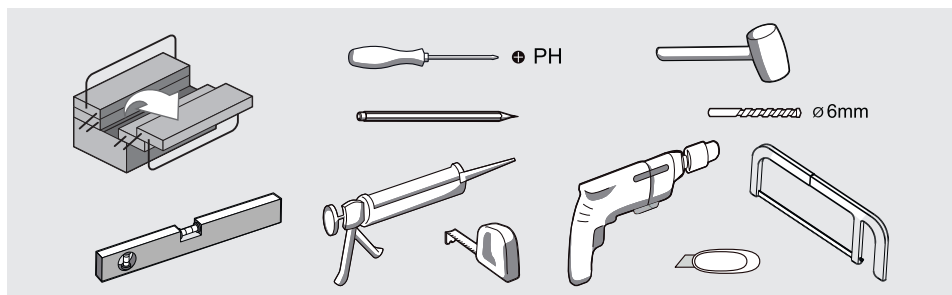
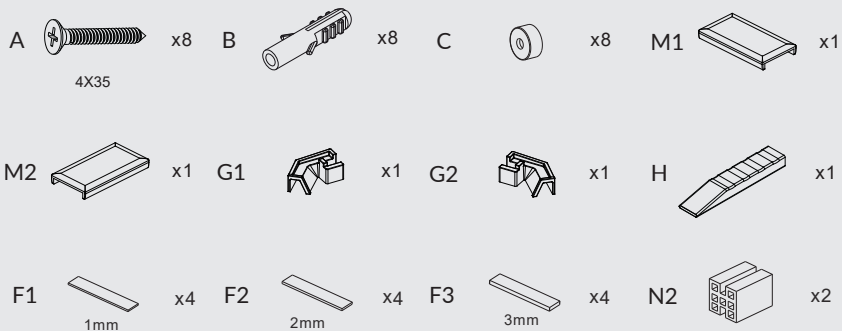
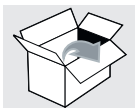

1.

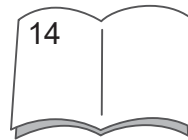
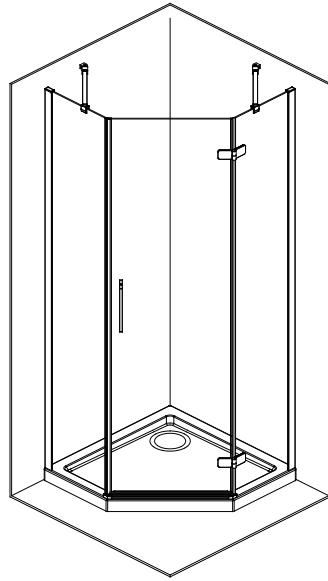
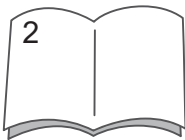
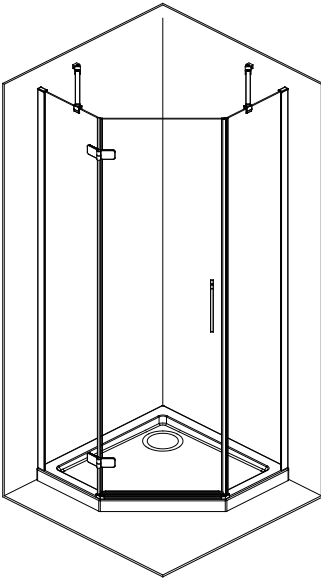

2.

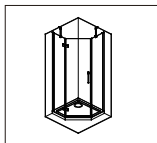

SIZE	X (mm)	Y (mm)
800X800X1950	785	785
900X900X1950	885	885

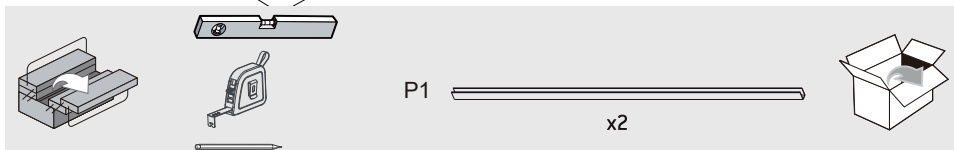
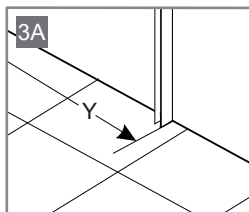
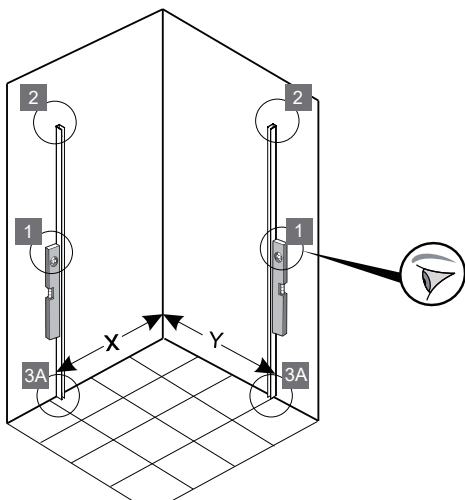
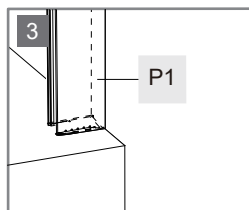
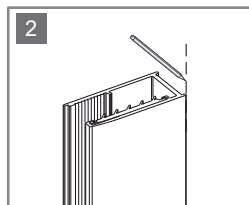
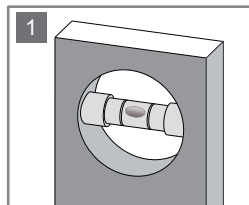
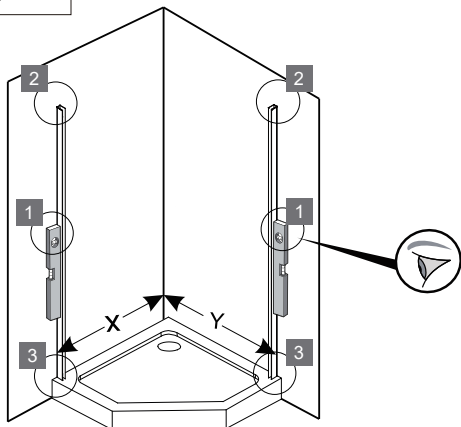

3.

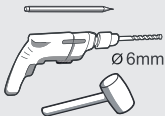
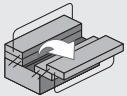
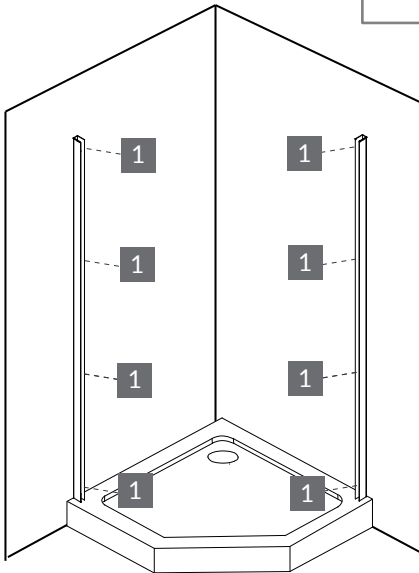
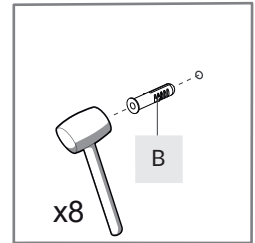
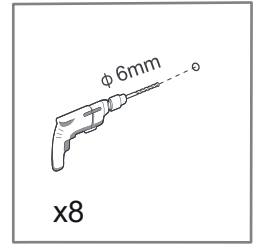
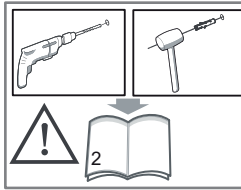
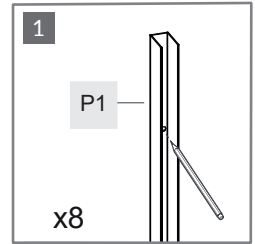
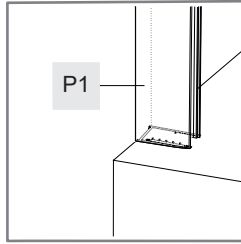
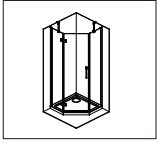

B



x8



4.

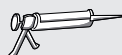
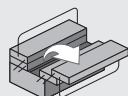
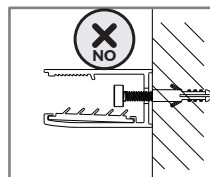
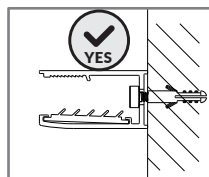
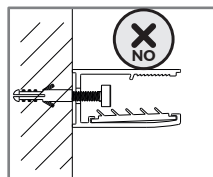
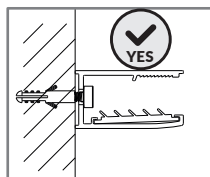
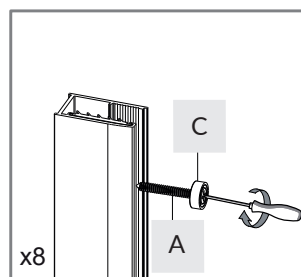
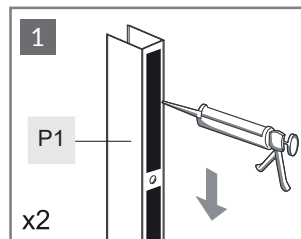
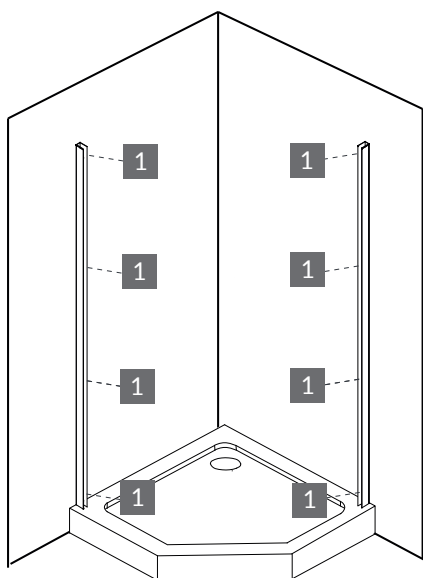
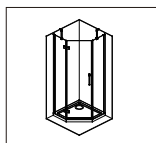

P1

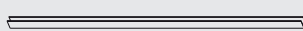

x2



PH2

C



x8

A



4x35

x8



5.

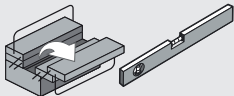
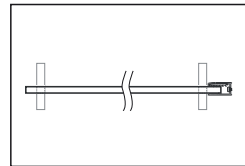
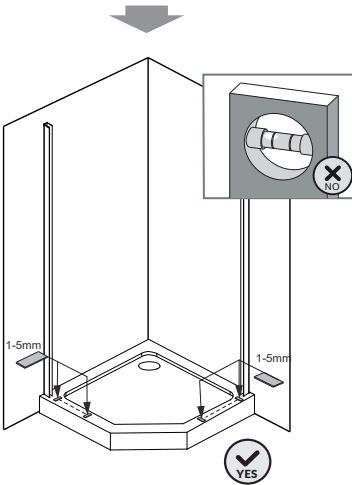
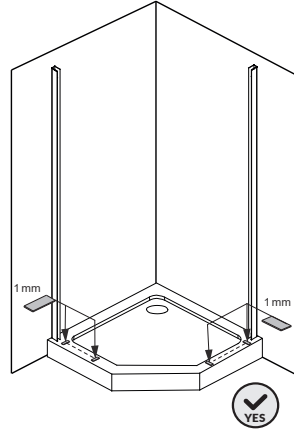
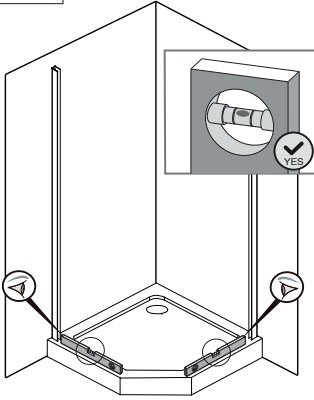
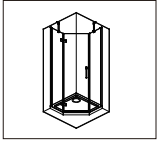

F1



1mm

x4

F2



2mm

x4

F3



3mm

x4



6.

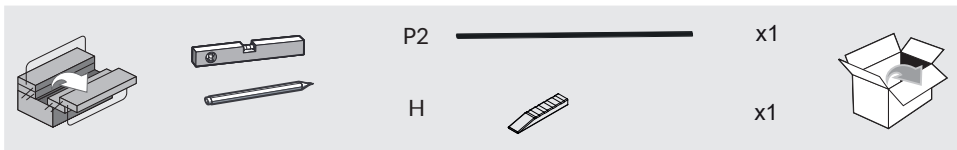
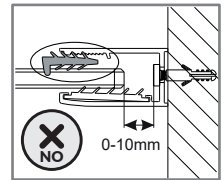
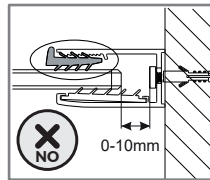
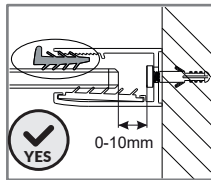
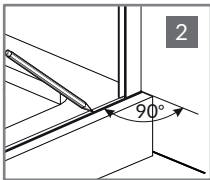
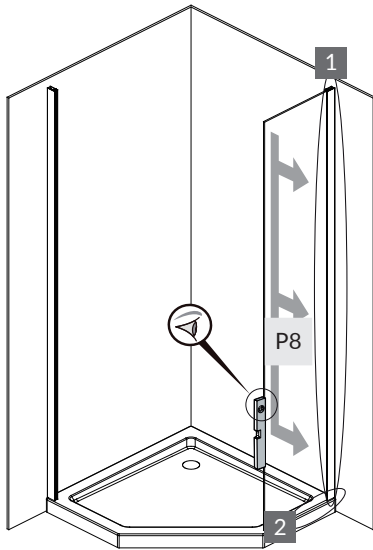
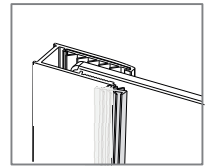
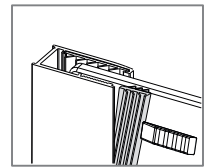
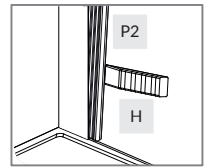
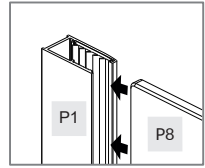
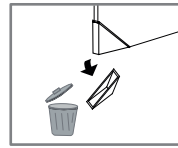
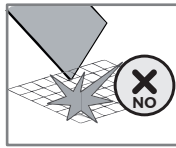
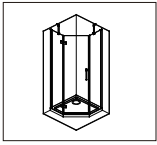

7.

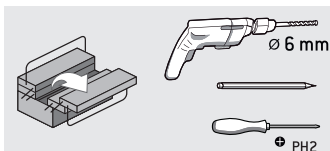
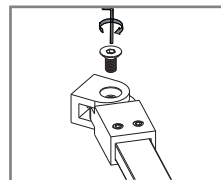
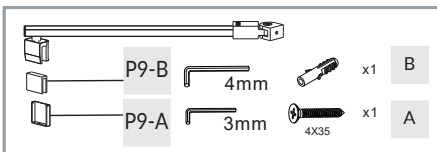
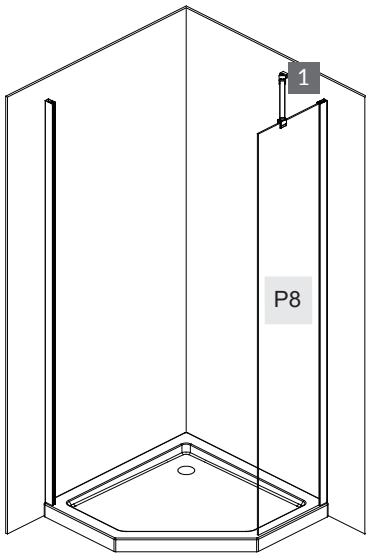
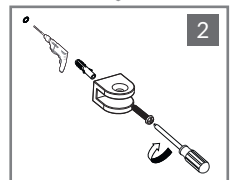
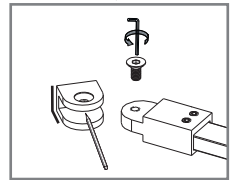
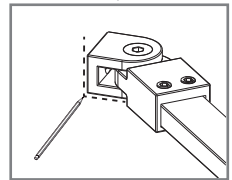
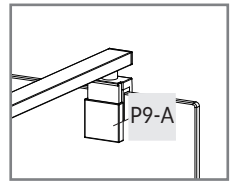
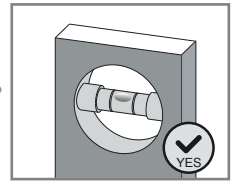
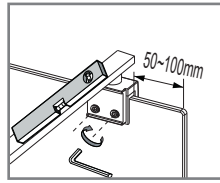
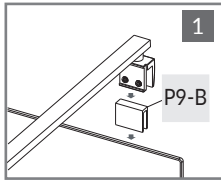
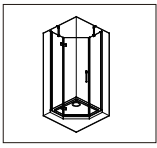

8.

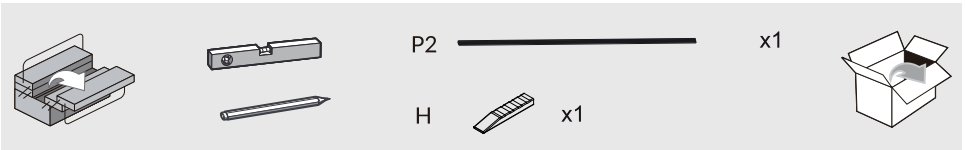
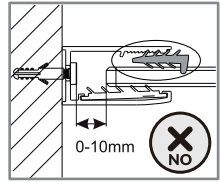
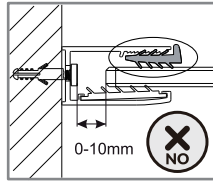
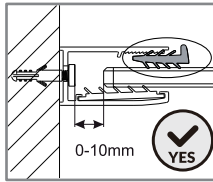
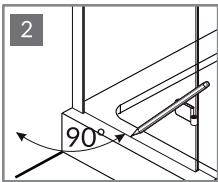
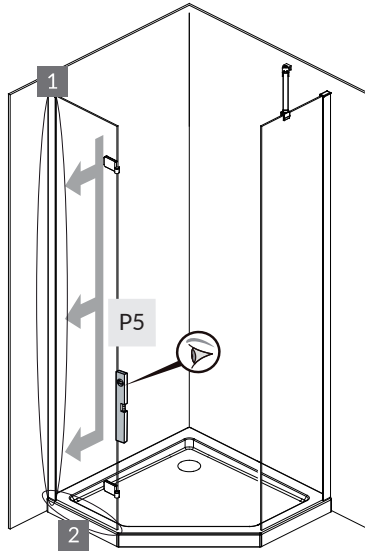
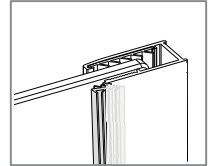
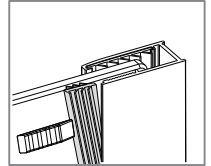
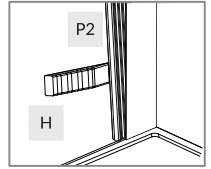
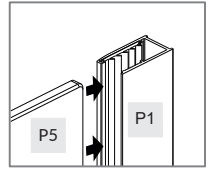
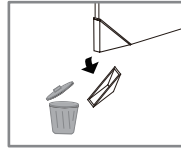
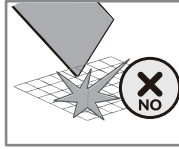
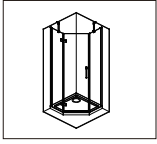

9.

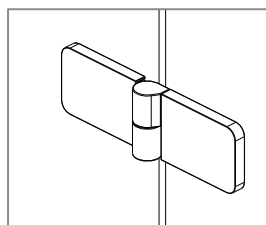
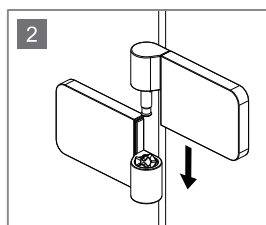
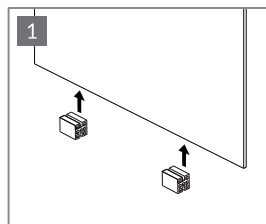
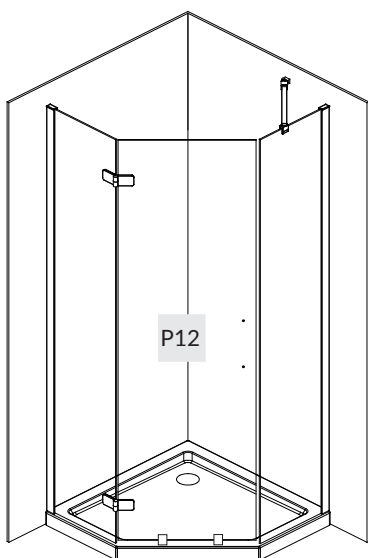
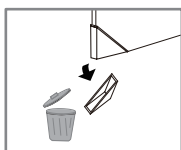
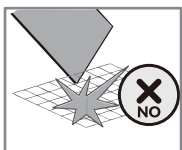
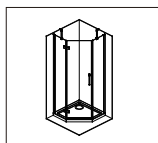

N2



x2



10.

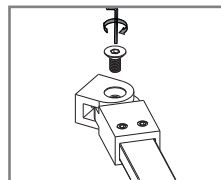
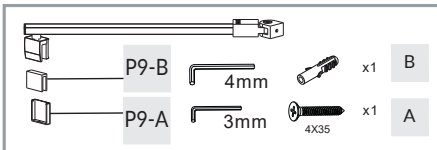
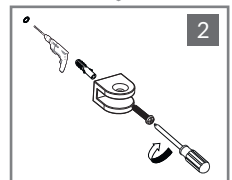
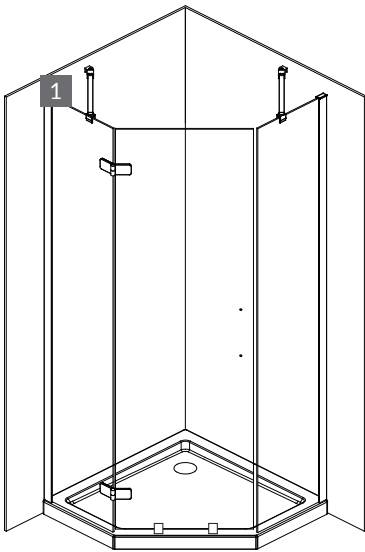
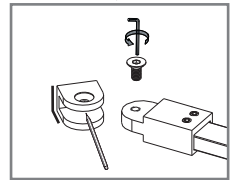
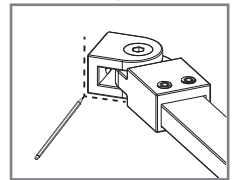
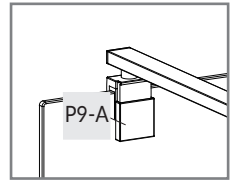
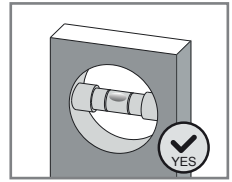
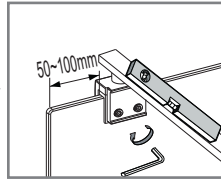
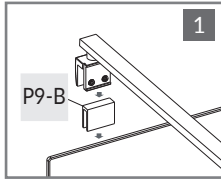
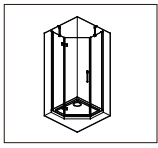

11.

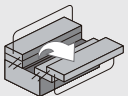
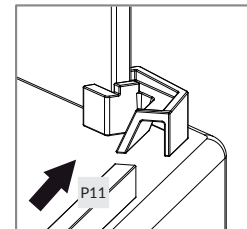
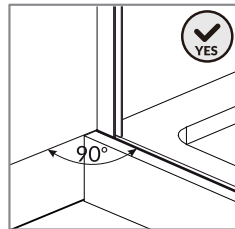
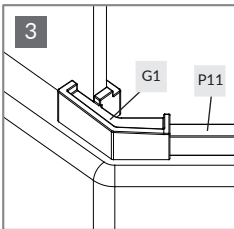
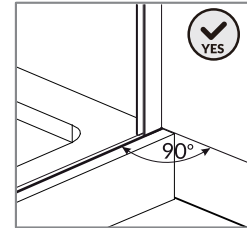
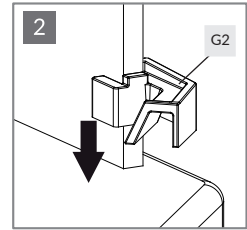
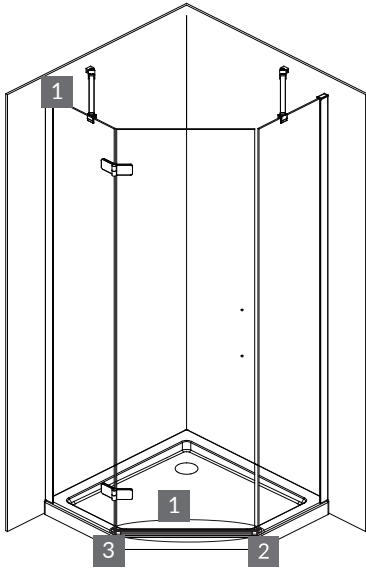
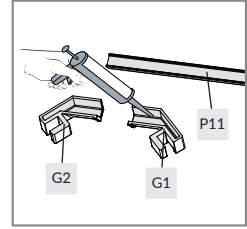
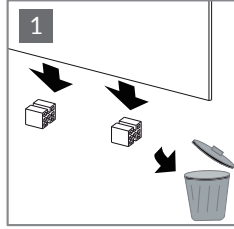
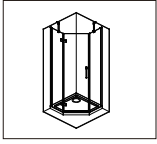

G1  x1

P11  x1

G2  x1



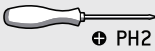
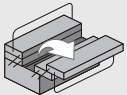
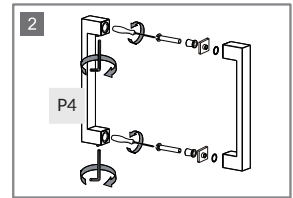
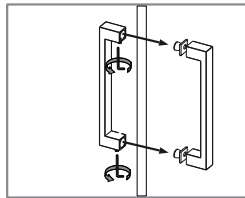
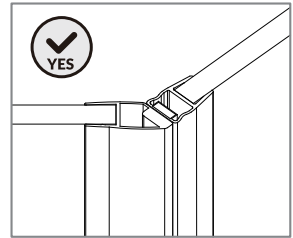
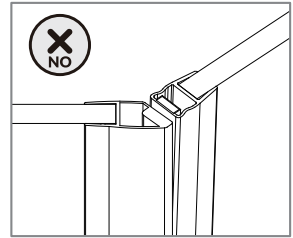
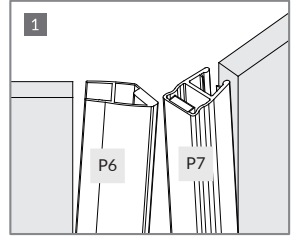
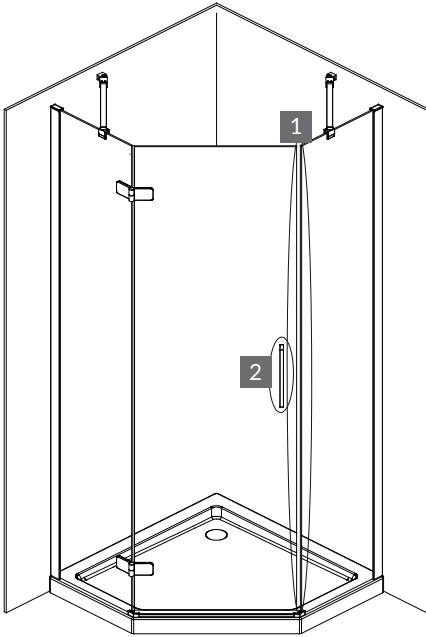
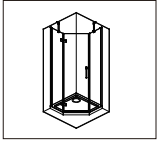

12.



P6 ————— x1

P7 ————— x1

P4  x1 



13.

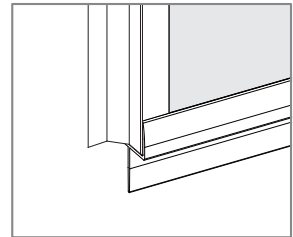
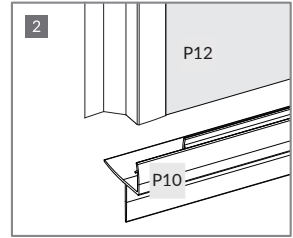
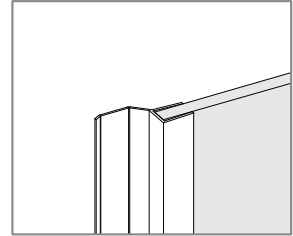
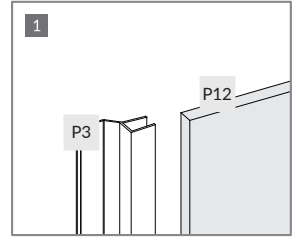
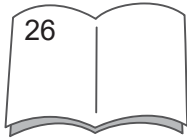
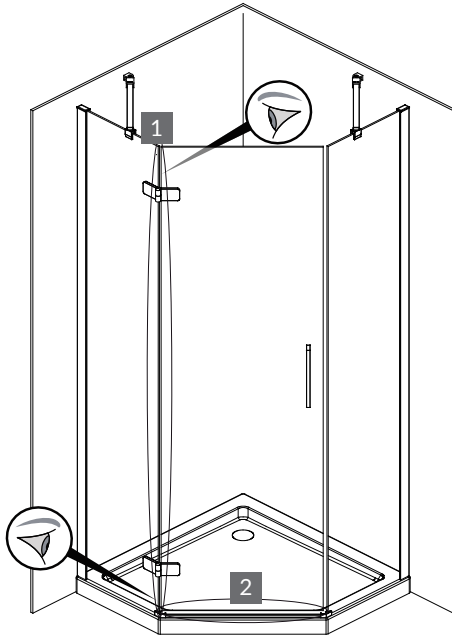
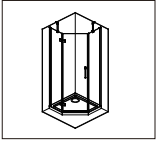

P3 ————— x1

P10 ————— x1



14.

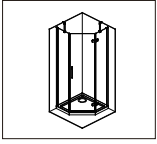

SIZE	X (mm)	Y (mm)
800X800X1950	785	785
900X900X1950	885	885

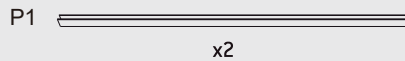
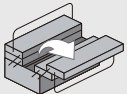
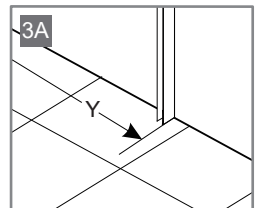
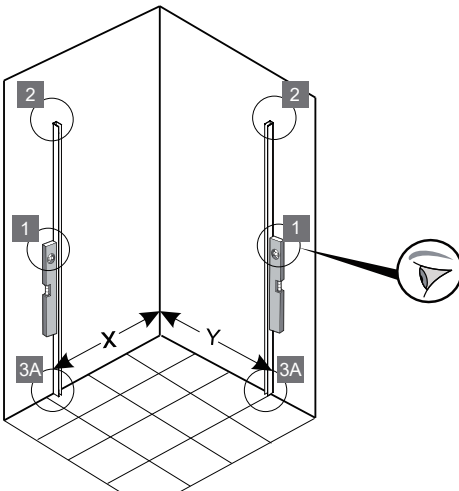
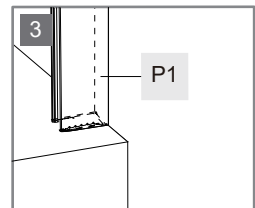
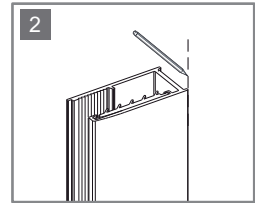
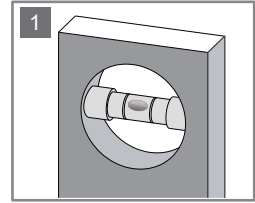
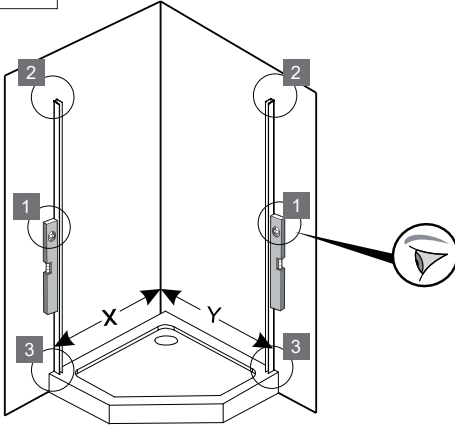

15.

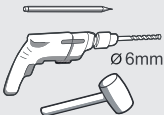
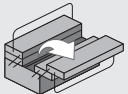
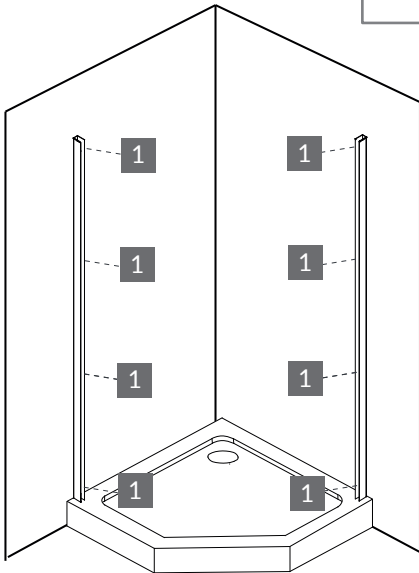
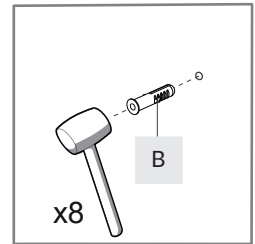
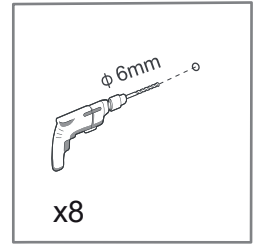
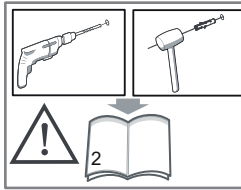
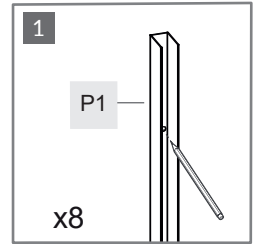
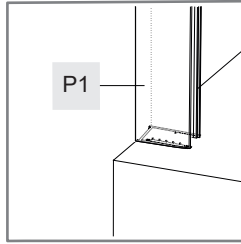
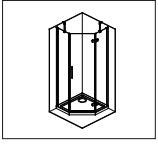

B



x8

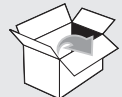

16.

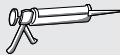
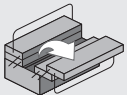
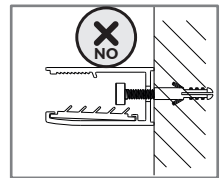
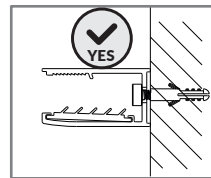
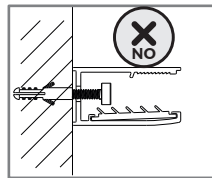
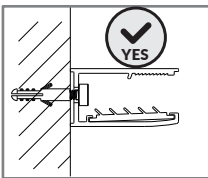
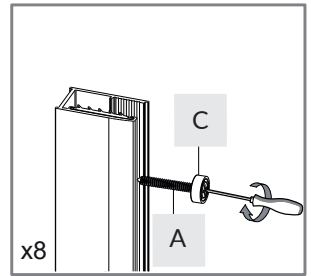
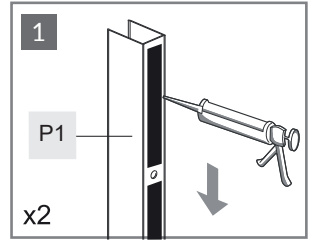
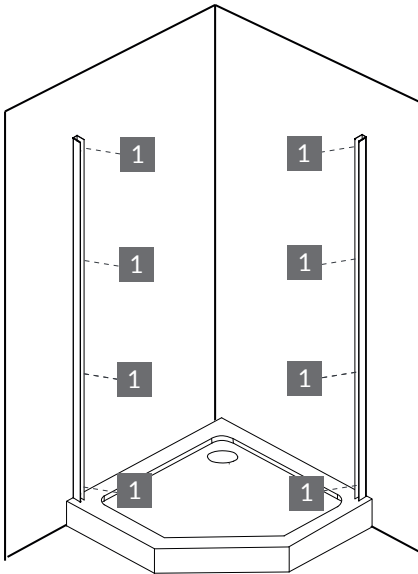
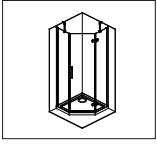

P1



x2



PH2

C



x8

A



4x35

x8



17.

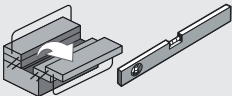
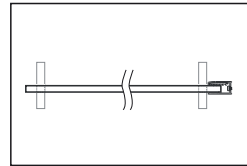
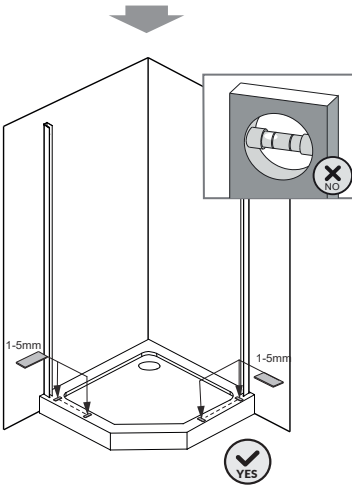
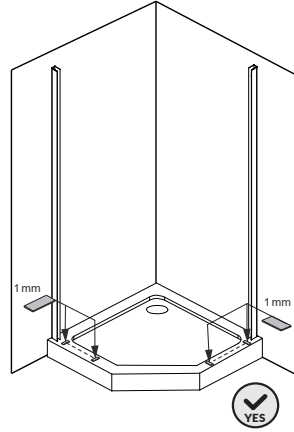
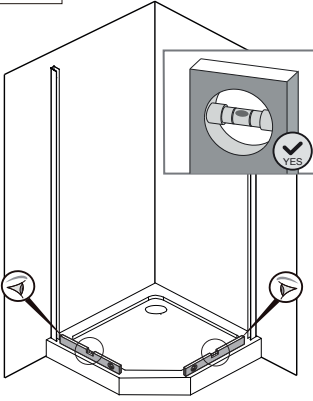
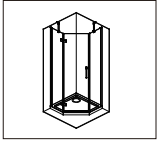

F1



1mm

x4

F2



2mm

x4

F3



3mm

x4



18.

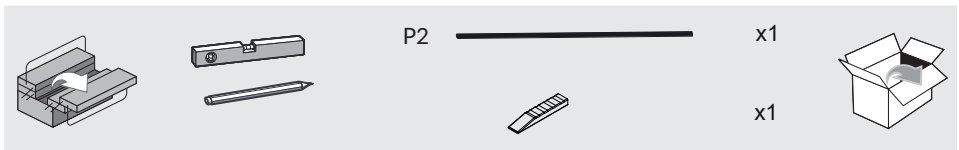
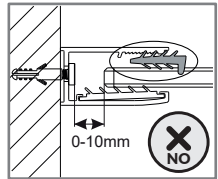
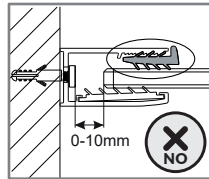
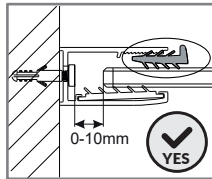
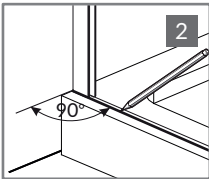
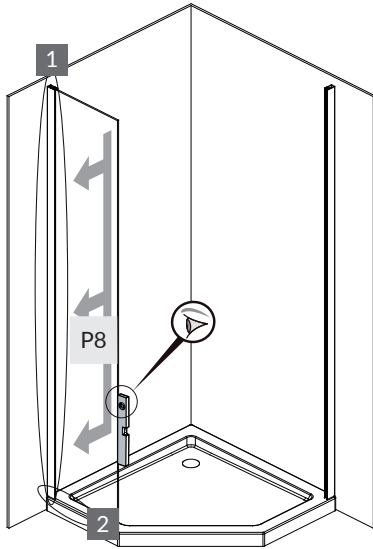
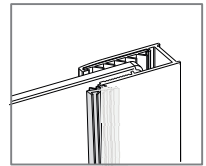
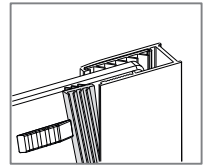
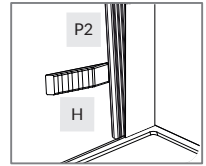
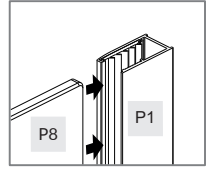
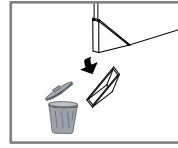
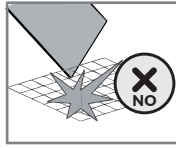
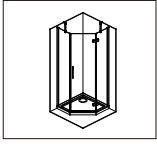

19.

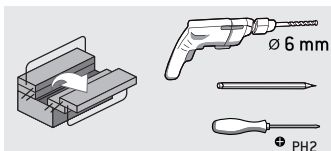
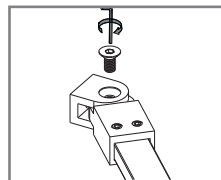
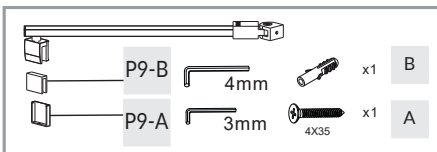
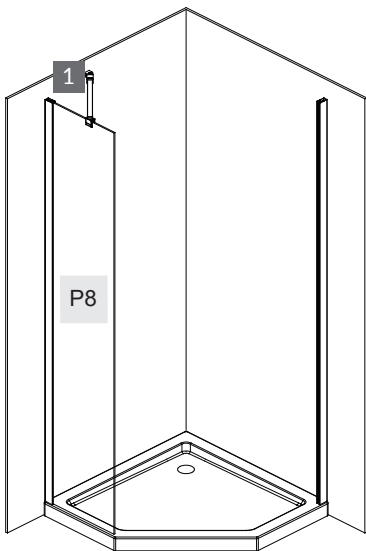
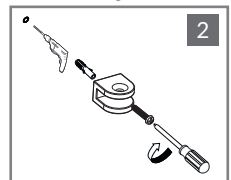
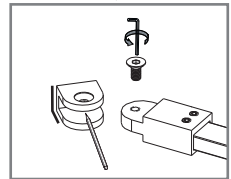
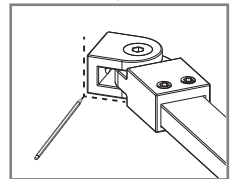
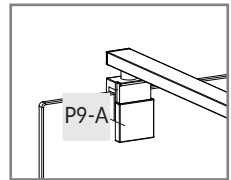
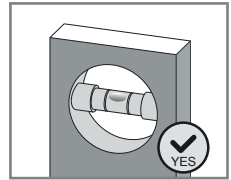
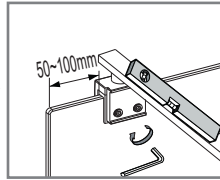
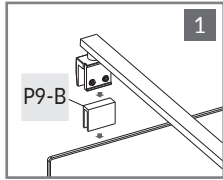
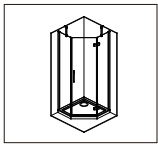

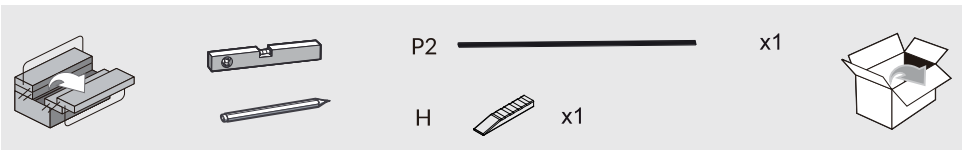
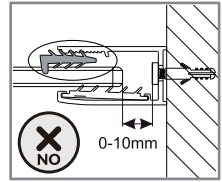
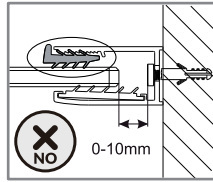
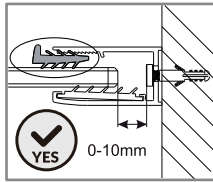
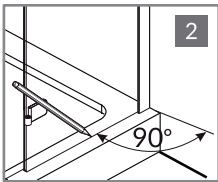
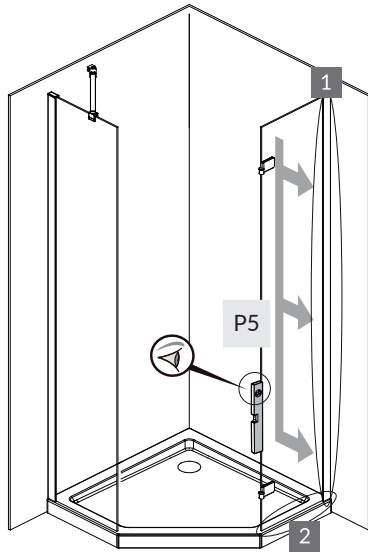
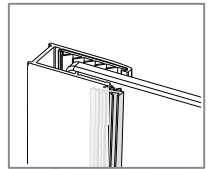
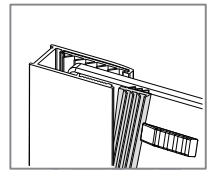
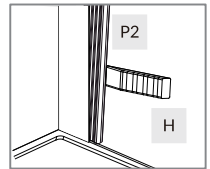
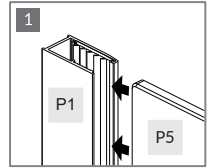
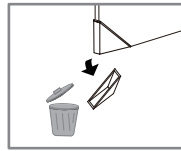
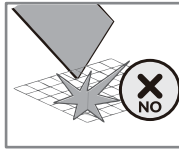
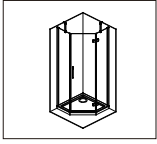

21.

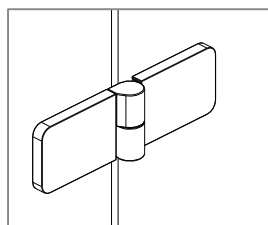
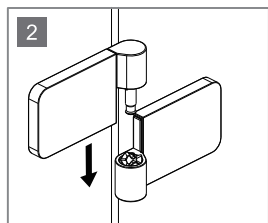
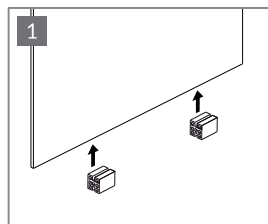
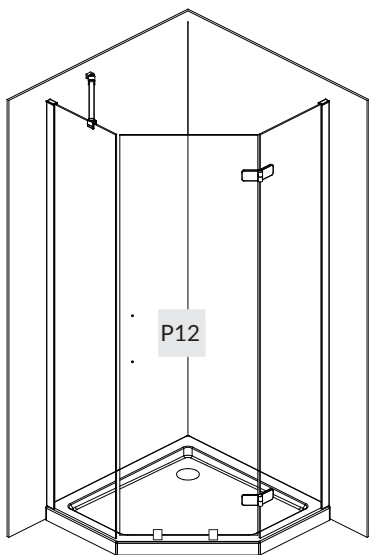
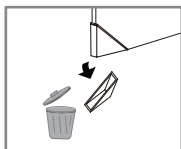
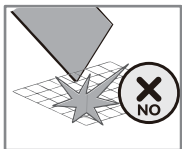
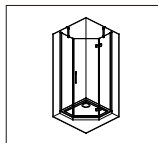

N2



x2



22.

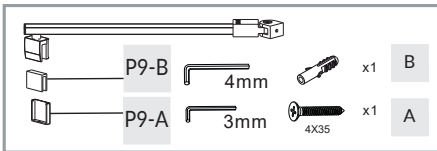
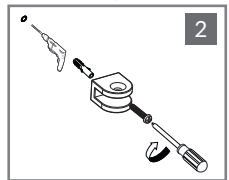
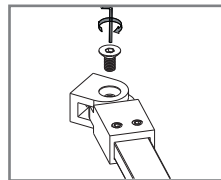
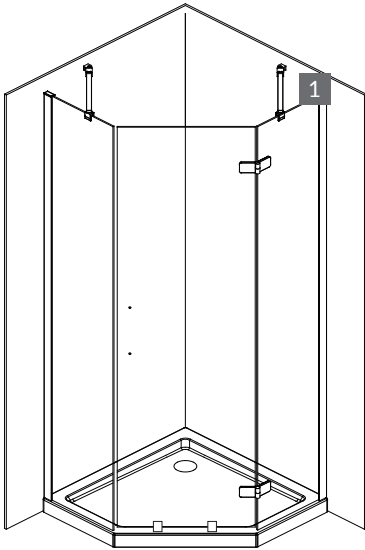
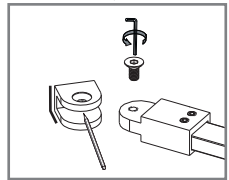
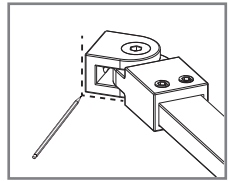
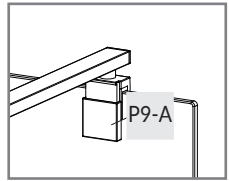
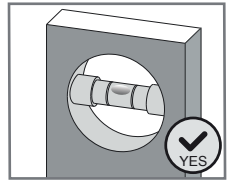
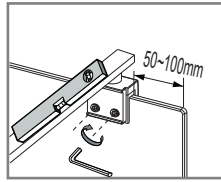
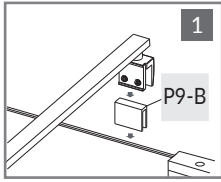
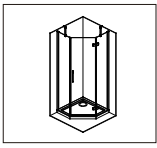

23.

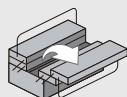
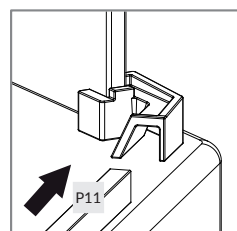
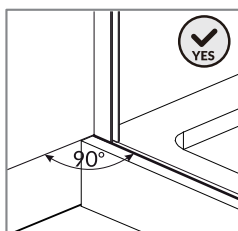
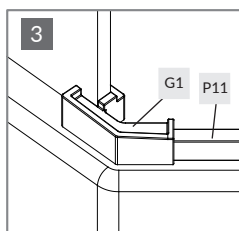
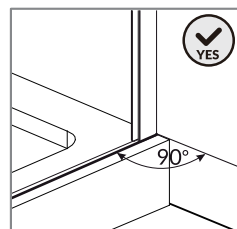
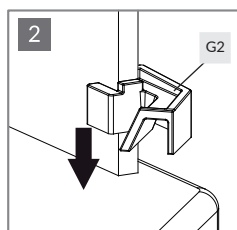
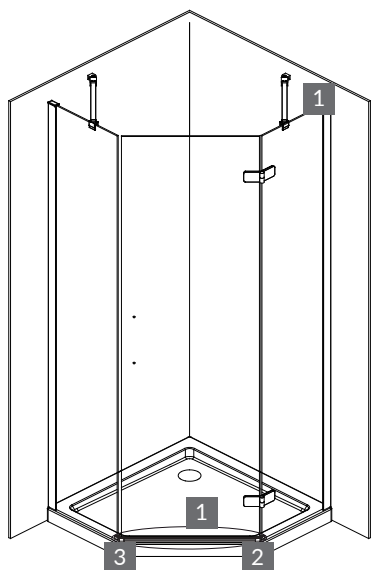
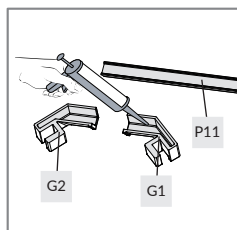
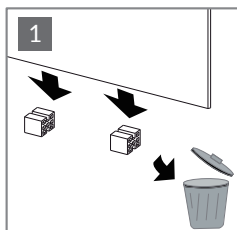
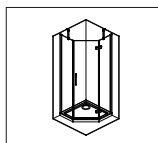

G1



x1

P11

x1

G2



x1



24.

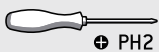
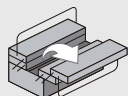
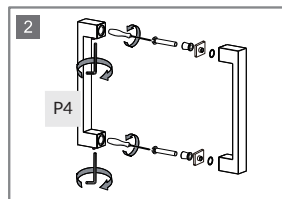
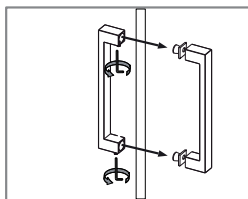
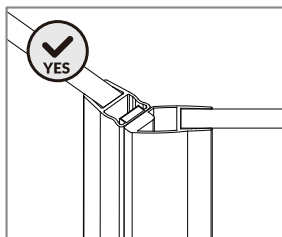
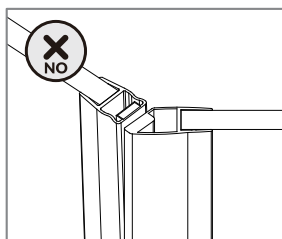
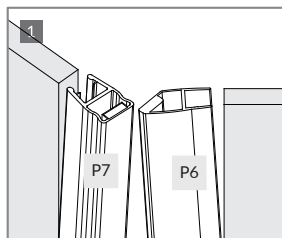
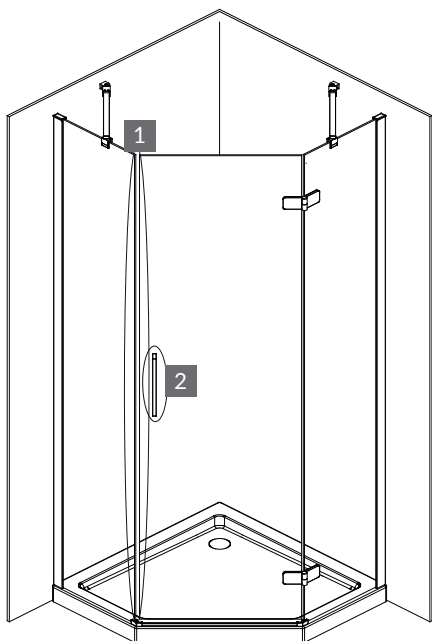
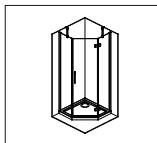

PH2

P6 ————— x1

P7 ————— x1

P4  x1 



25.

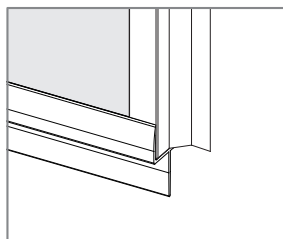
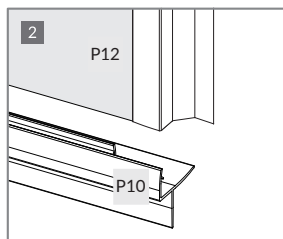
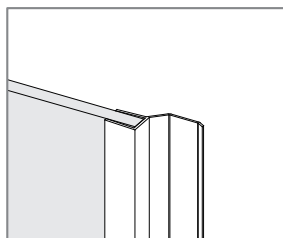
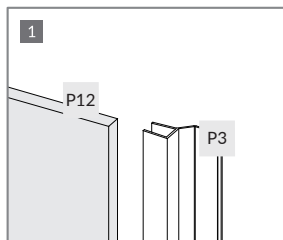
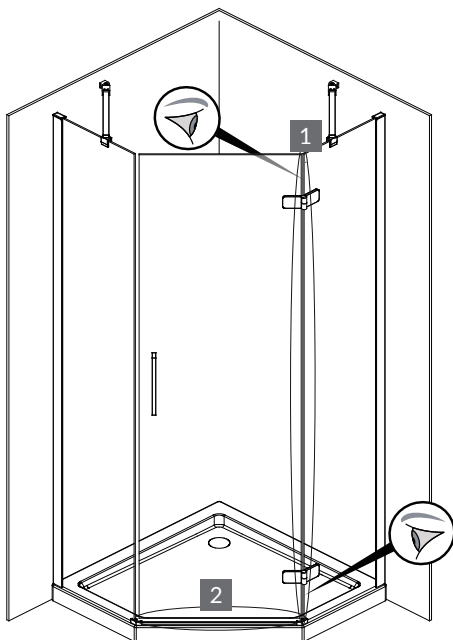
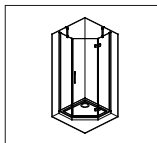

P3 ————— x1

P10 ————— x1



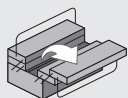
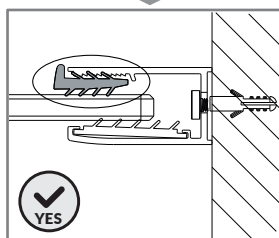
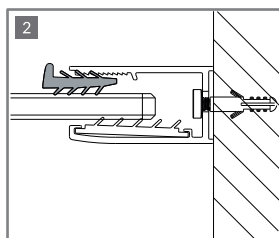
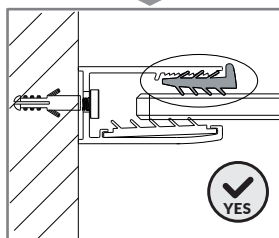
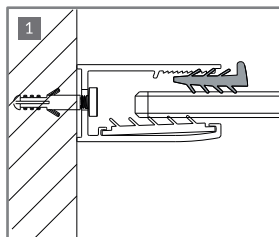
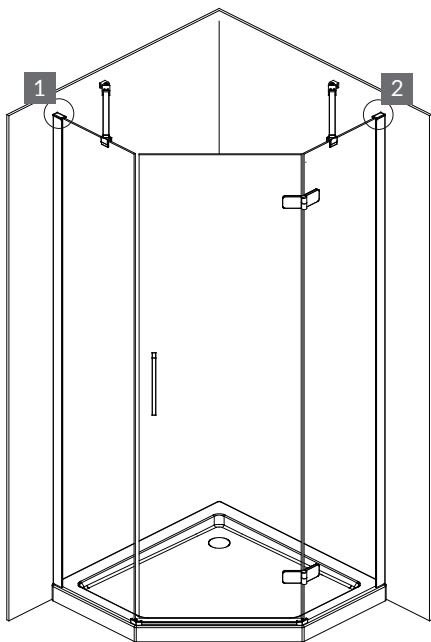

H



x1



27.

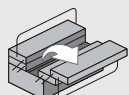
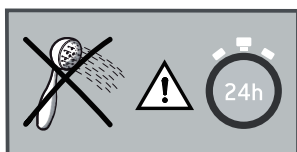
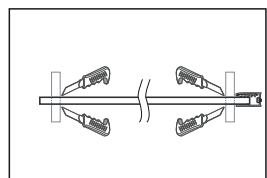
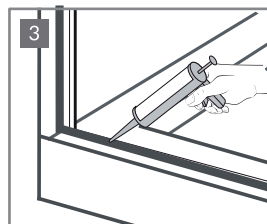
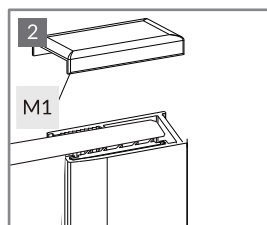
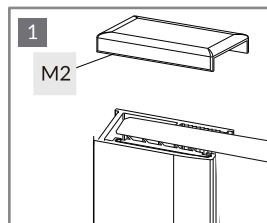
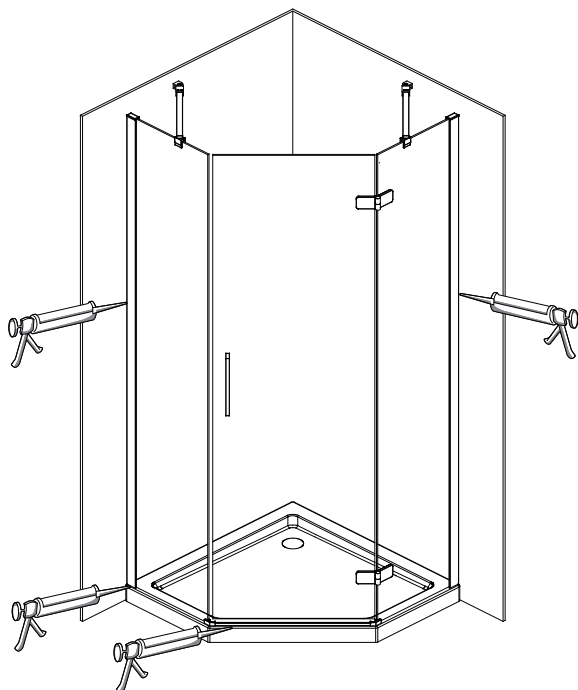

M1 x1

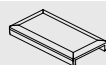

M2 x1

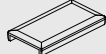



6.5 < PH < 7.5

