

ARTECO

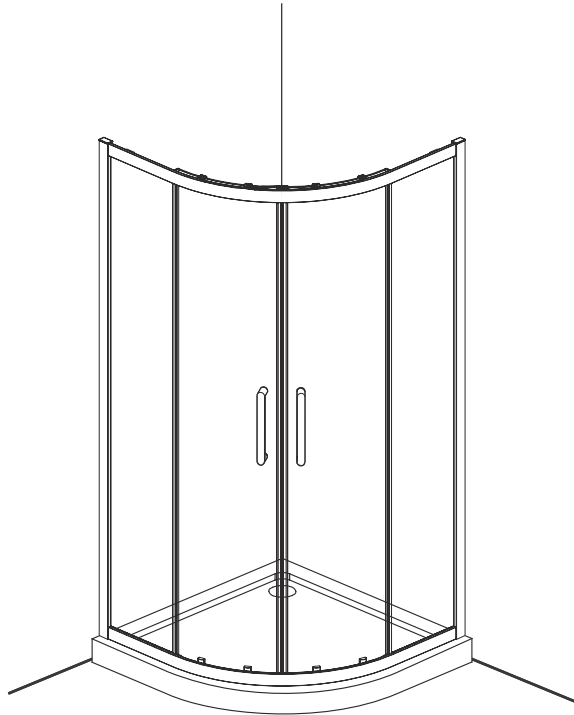

PL INSTRUKCJA MONTAŻU I EKSPLOATACJI

CZ NÁVOD NA MONTÁŽ A ÚDRŽBU

SK NÁVOD NA MONTÁŽ A ÚDRŽBU

EST PAIGALDUS- JA KASUTUSJUHEND

LT MONTAVIMO IR EKSPLOATAVIMO INSTRUKCIJA

LV MONTĀŽAS UN EKSPLUATĀCIJAS INSTRUKCIJA

DE MONTAGE- UND AUFBAUANLEITUNG

RO INSTRUCȚIUNI DE MONTAJ ȘI OPERARE

HU SZERELÉSI ÉS ÜZEMELTETÉSI ÚTMUTATÓ

UA ІНСТРУКЦІЯ З МОНТАЖУ І ЕКСПЛУАТАЦІЇ

BY ІНСТРУКЦЫЯ ПА МАНТАЖЫ І ЭКСПЛУАТАЦЫІ

RU ИНСТРУКЦИЯ ПО МОНТАЖУ И ЭКСПЛУАТАЦИИ

EN INSTRUCTIONS FOR ASSEMBLY AND USE

FR INSTALLATION ET UTILISATION - MODE

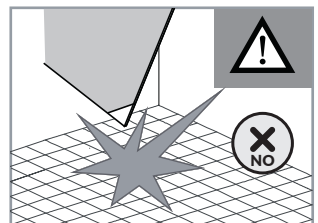
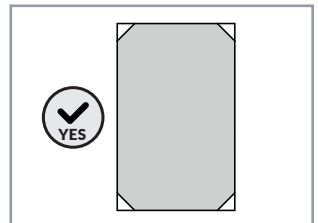
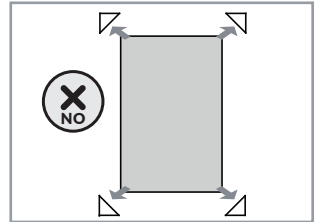
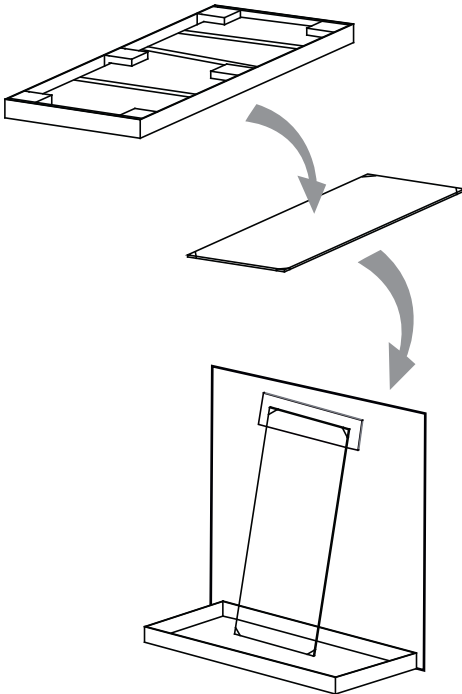
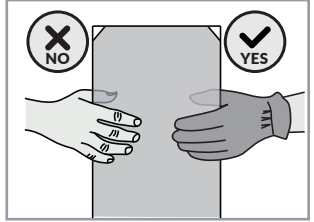
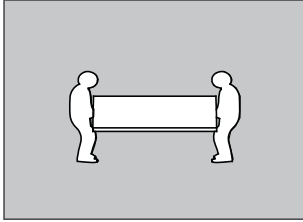
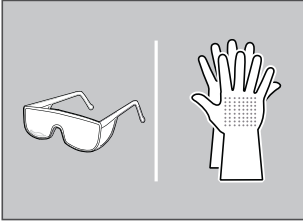
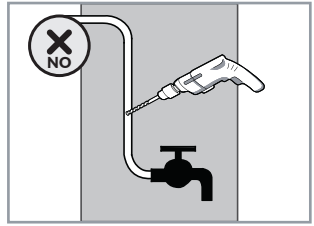
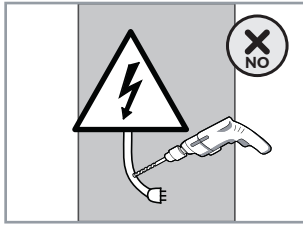
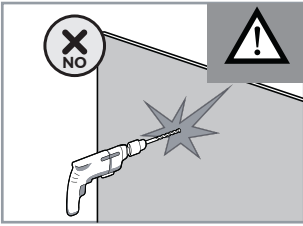

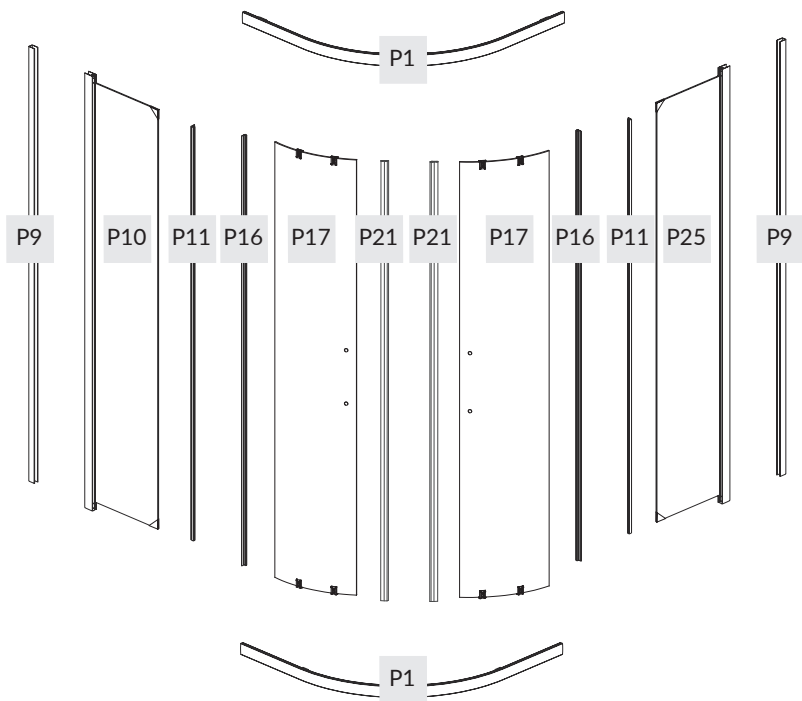

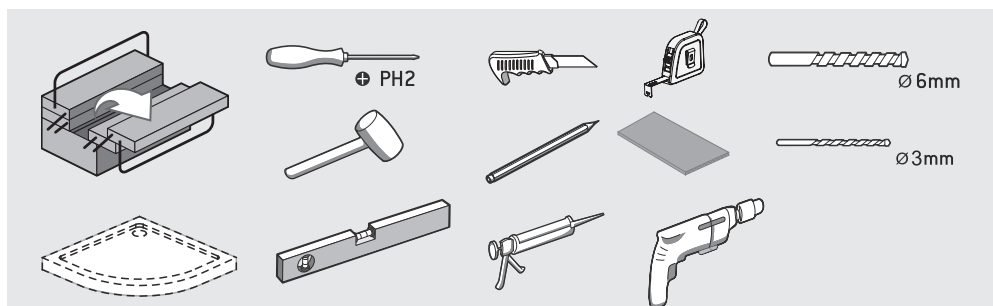
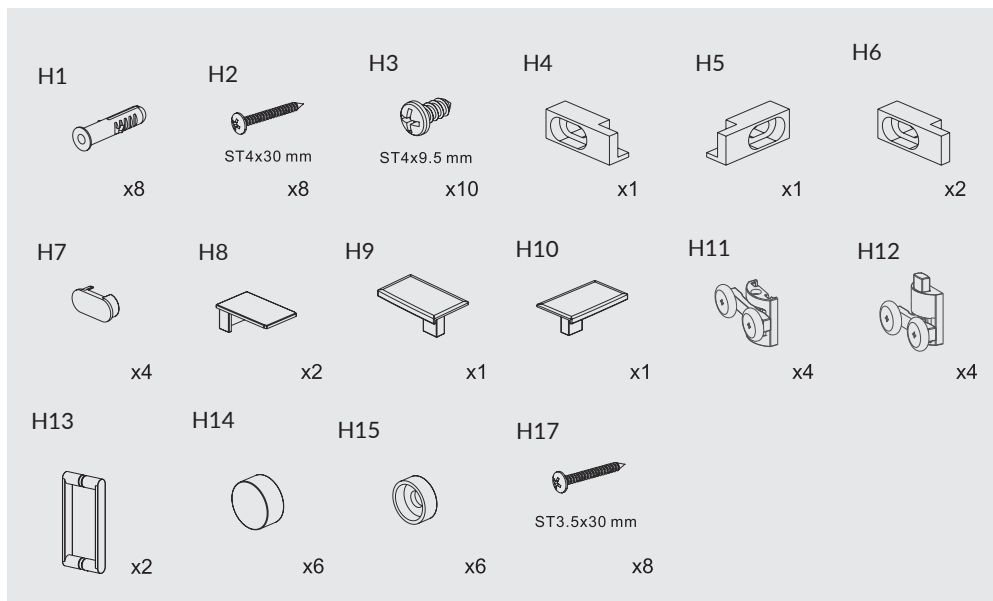
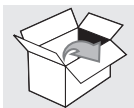

1.

SIZE(mm)	X(mm)	Y (mm)
800x800	783-798	783-798
900x900	883-898	883-898

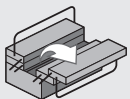
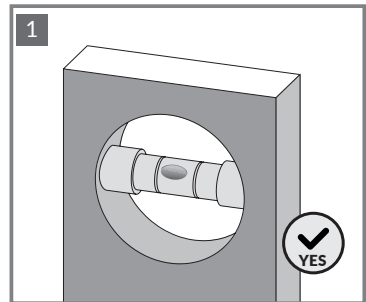
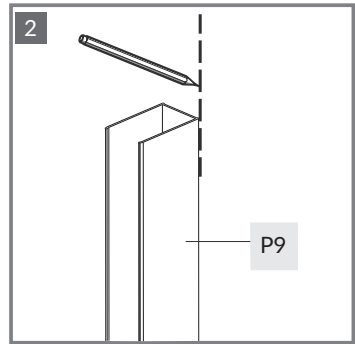
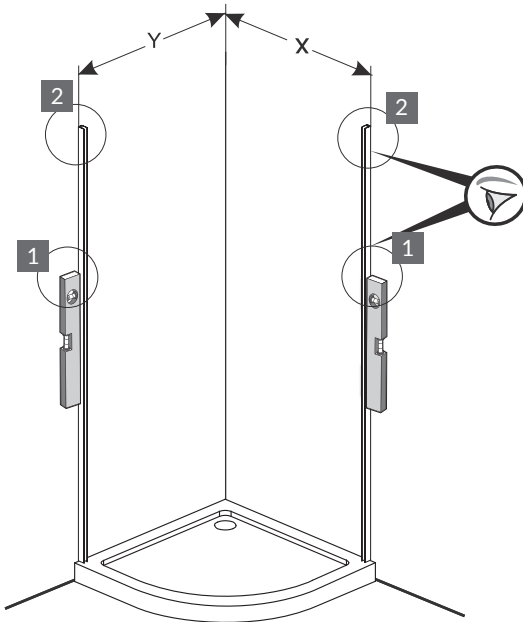

P9  x2



2.

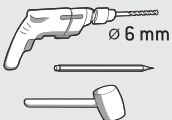
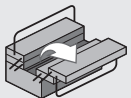
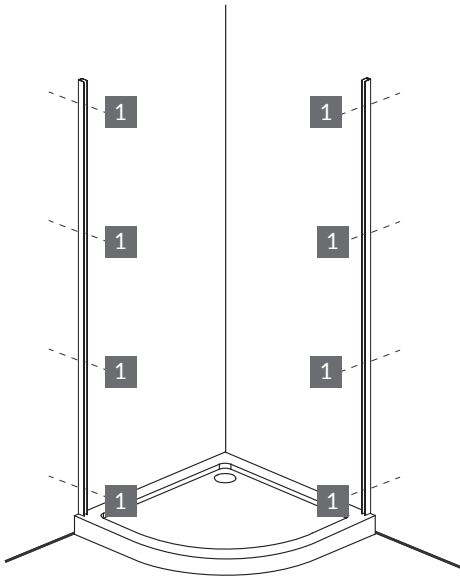
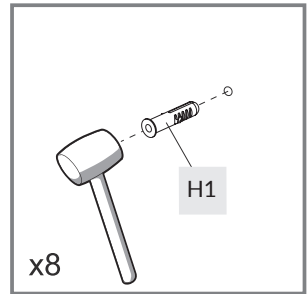
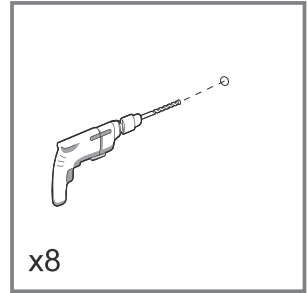
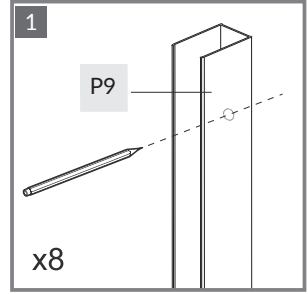
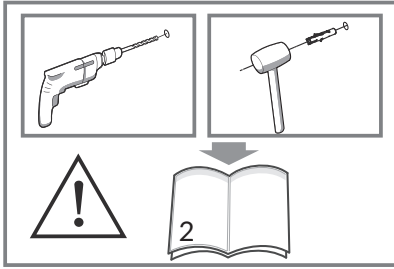

P9  x2

H1  x8



3.

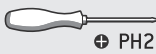
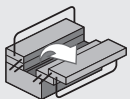
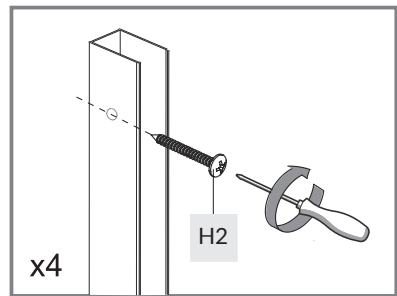
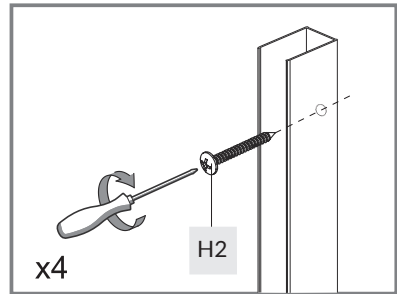
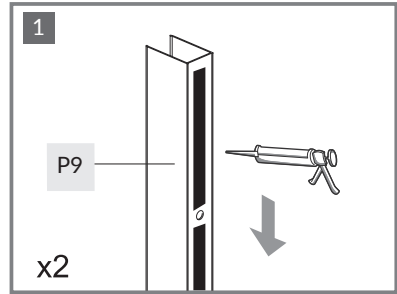
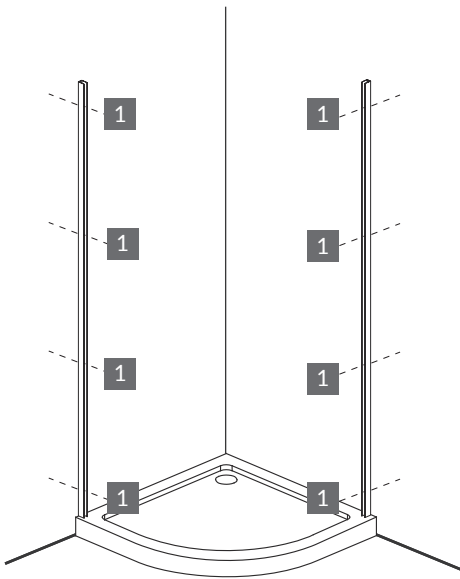

PH2

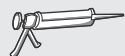

P9



x2

H2



x8



4.

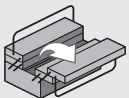
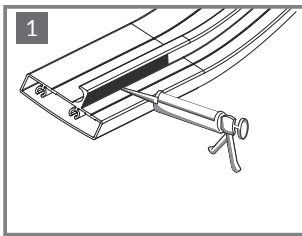
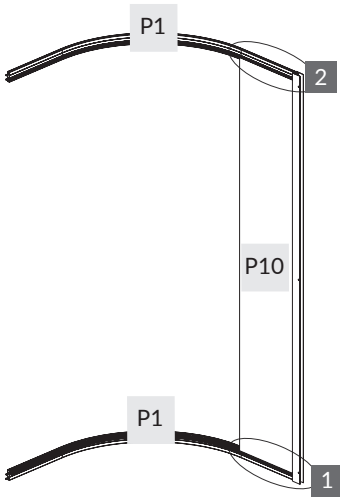
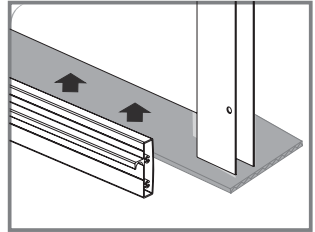
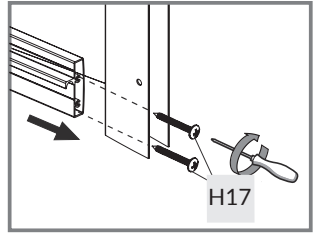
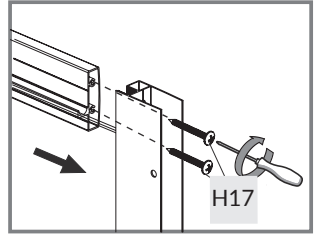
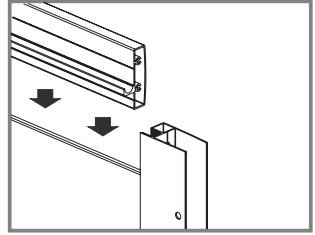
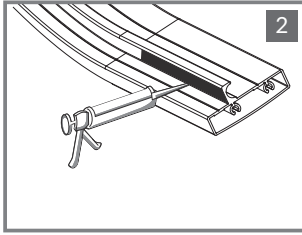

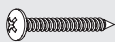
H17  x4



5.

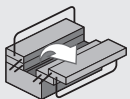
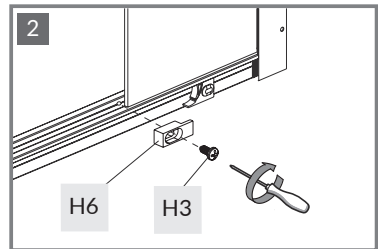
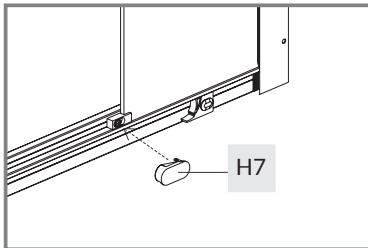
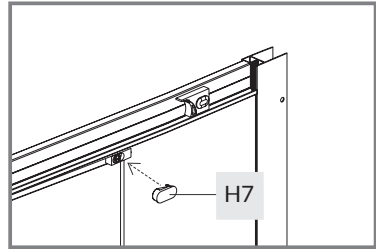
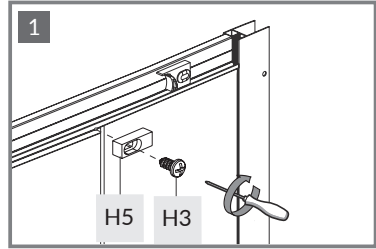
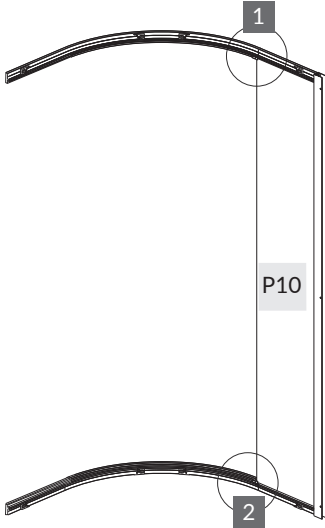

H3  x2

H6  x1

H5  x1

H7  x2



6.

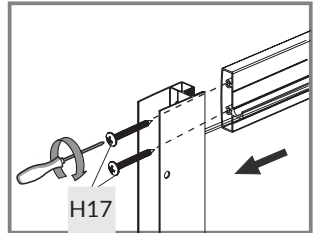
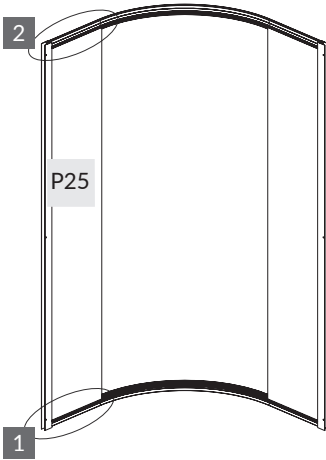
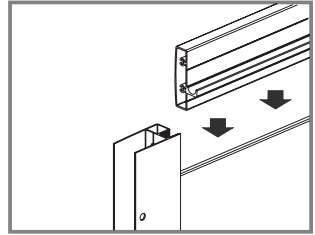
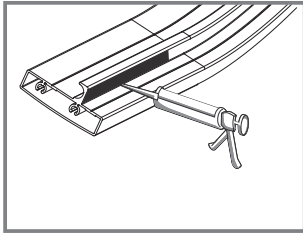

H17

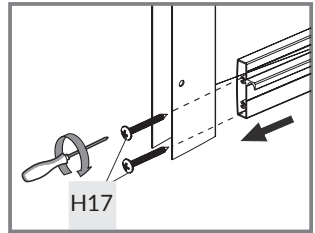

H17

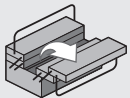
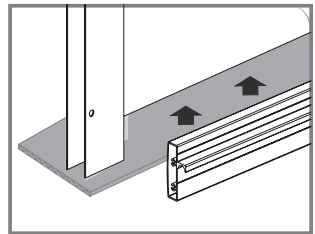
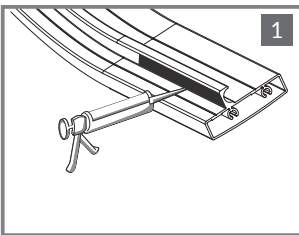

⊕ PH2

H17



x4



7.

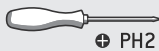
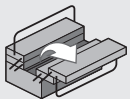
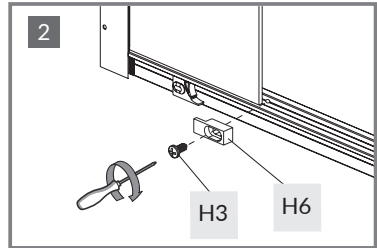
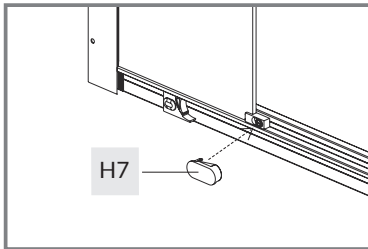
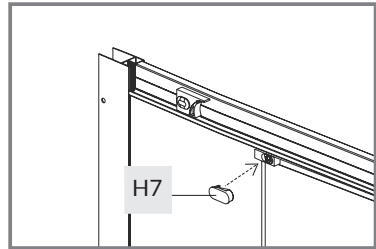
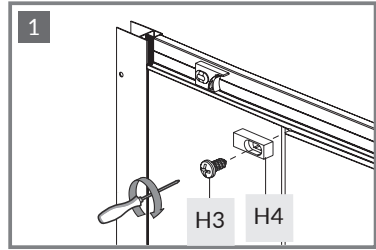
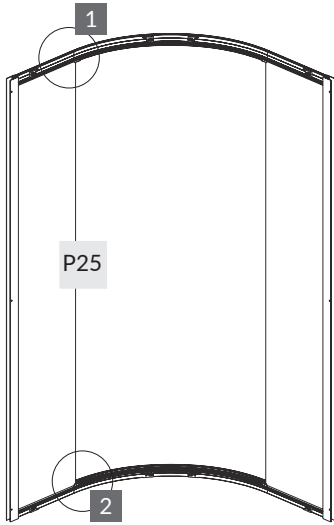

H3 x2



x2

H6 x1



x1

H4 x1



x1

H7 x2

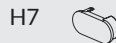

x2



8.

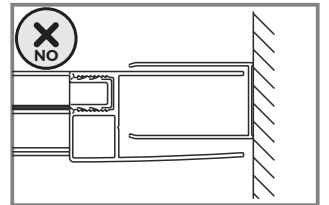
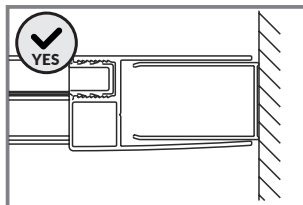
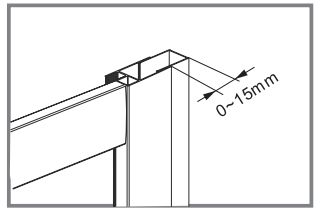
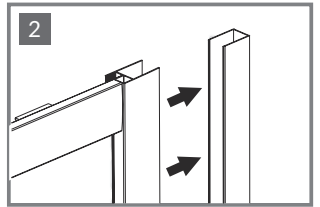
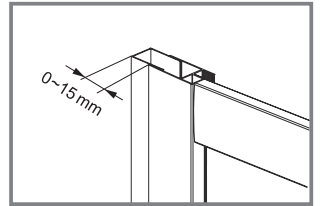
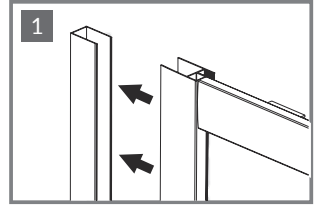
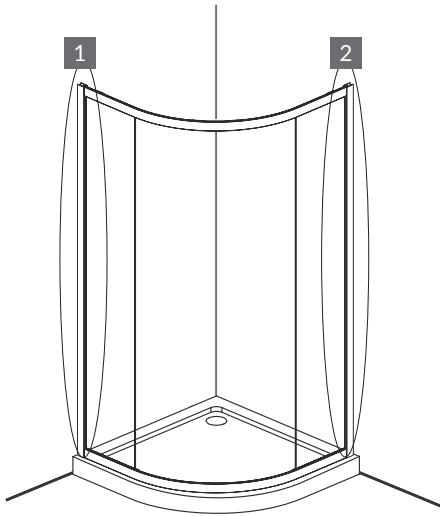

9.

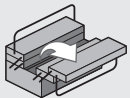
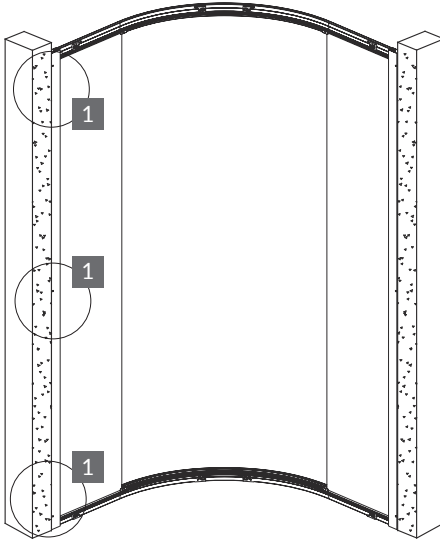
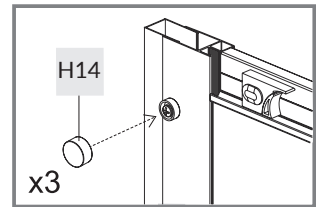
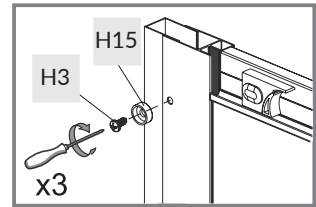
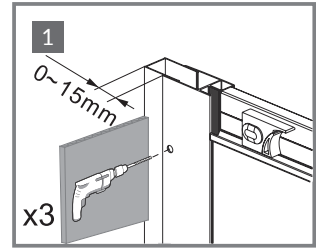
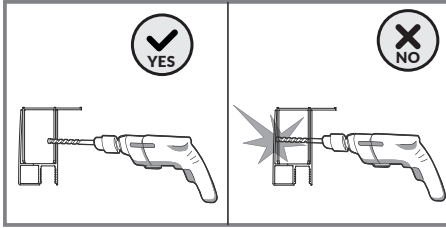

H3  x3

H14  x3

H15  x3



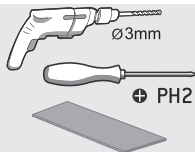
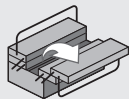
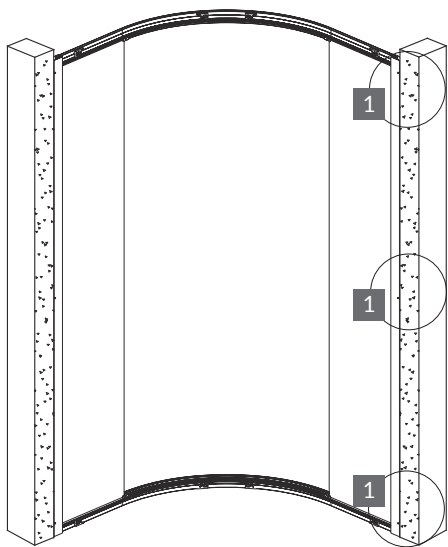
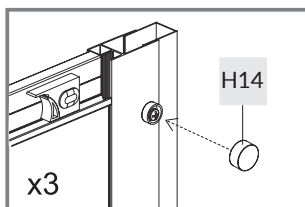
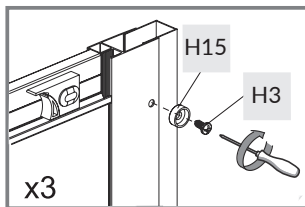
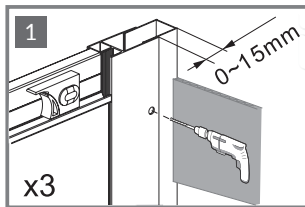
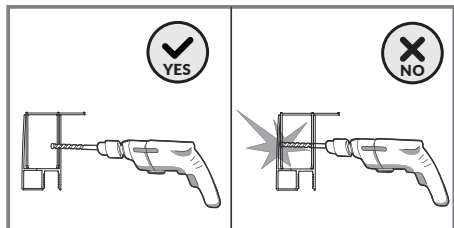

- | | | |
|-----|--|----|
| H3 | | x3 |
| H14 | | x3 |
| H15 | | x3 |



11.

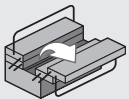
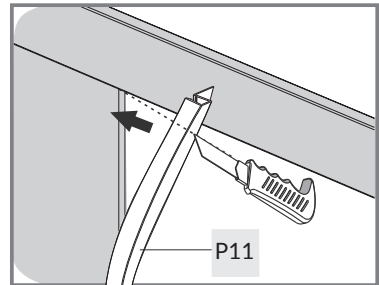
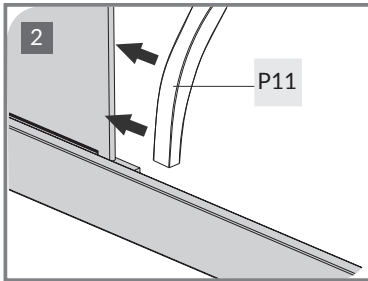
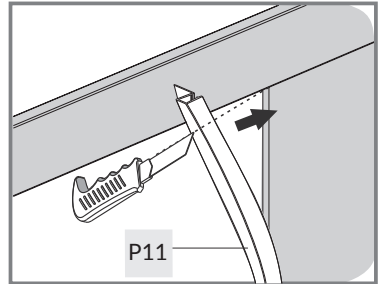
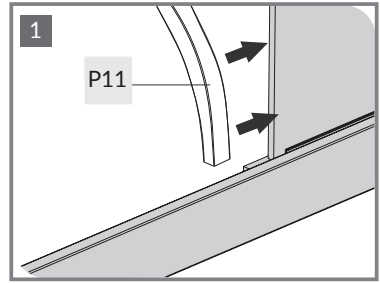
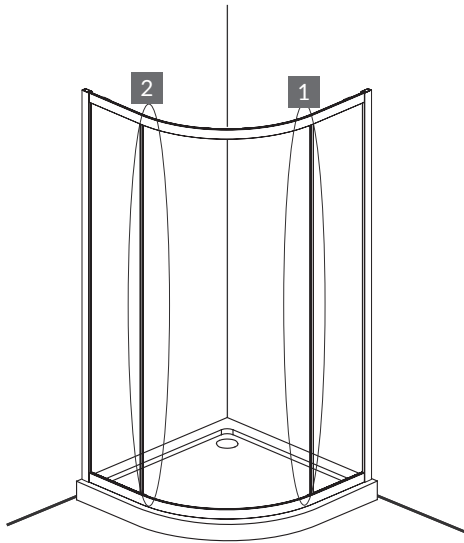

P11

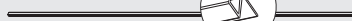

x2



12.

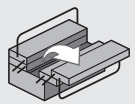
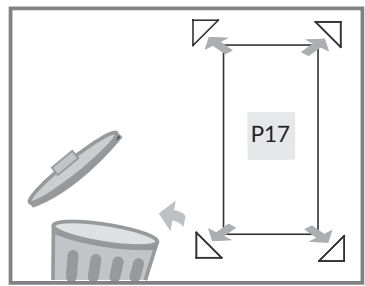
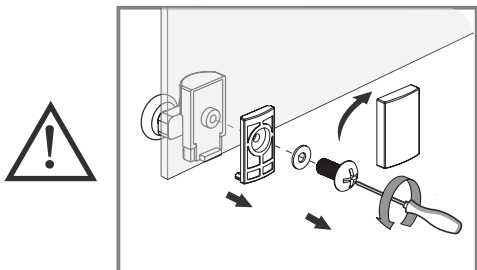
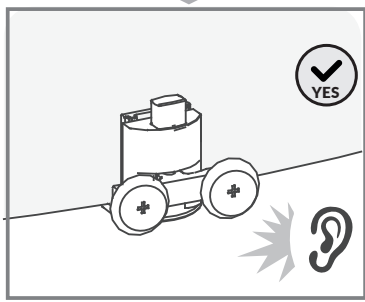
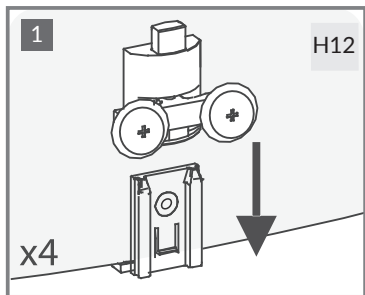
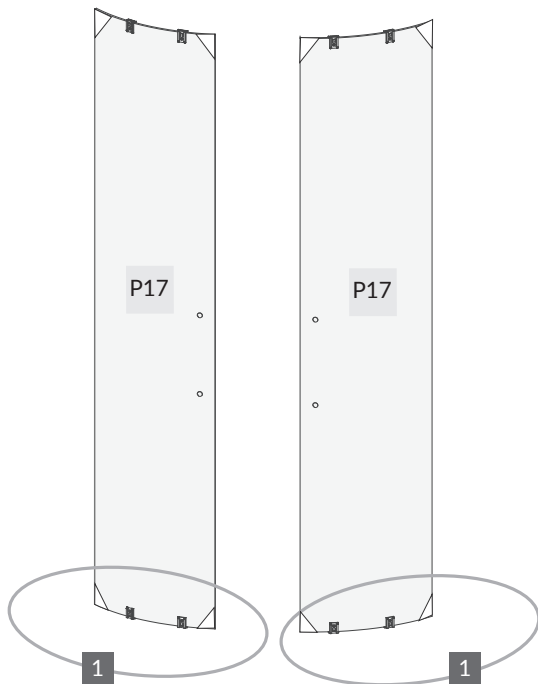

H12



x4



13.

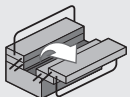
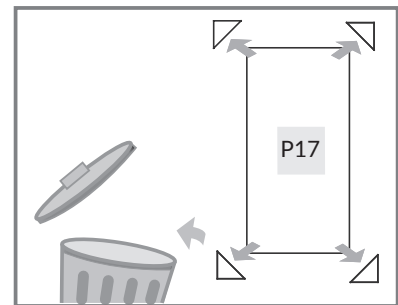
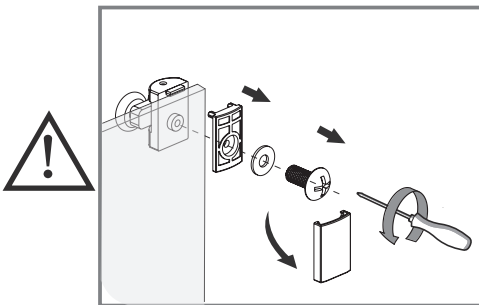
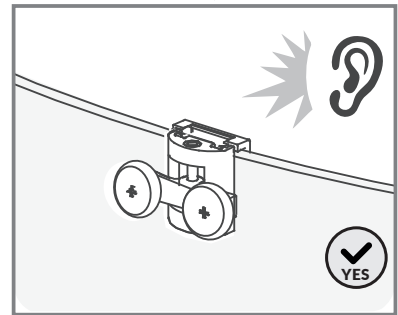
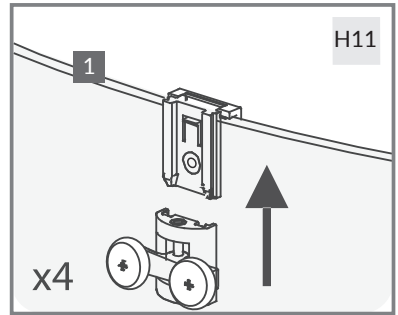
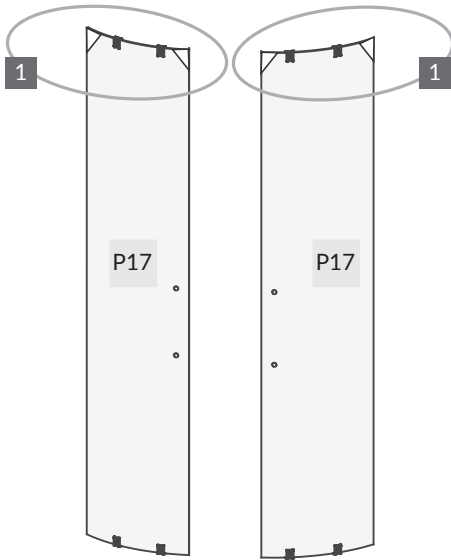

H11



x4



14.

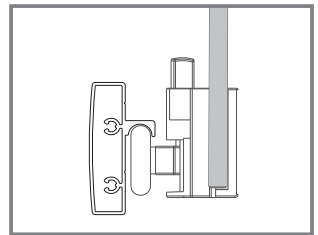
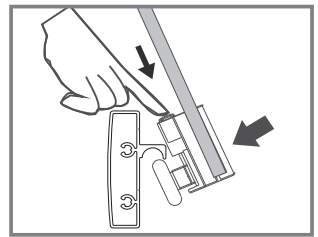
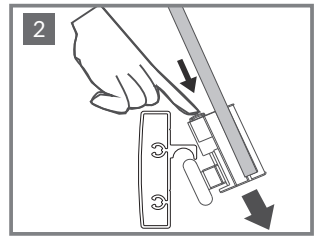
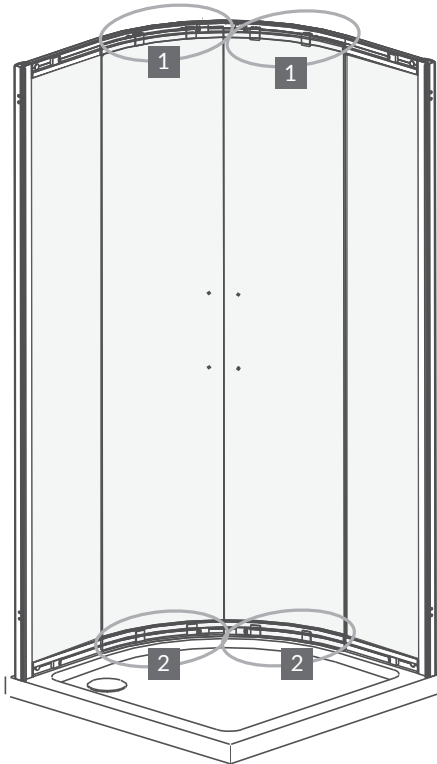
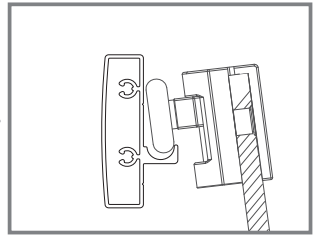
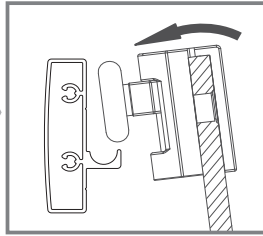
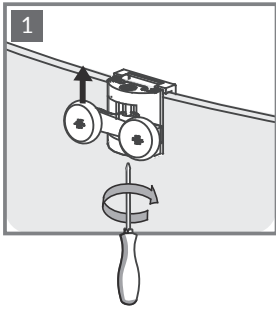

15.

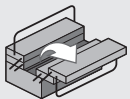
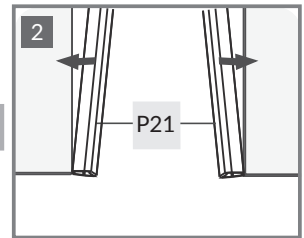
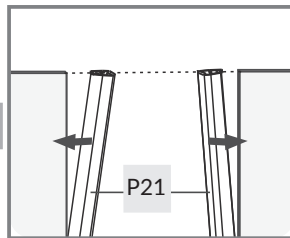
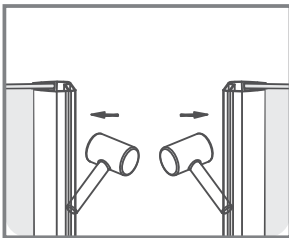
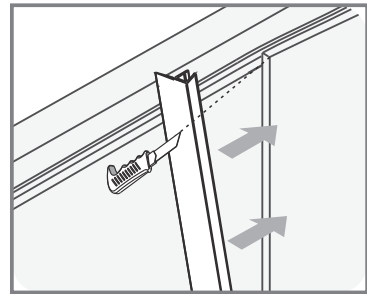
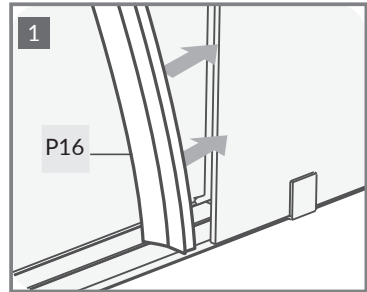
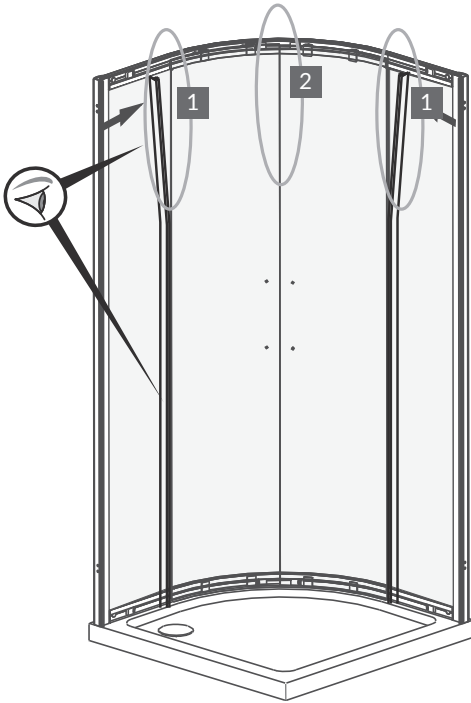

P16  x2

P21  x2



16.

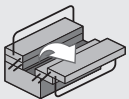
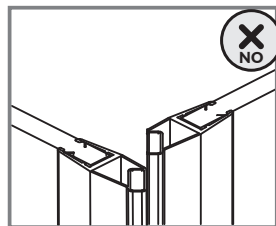
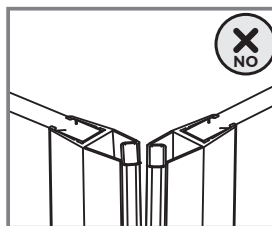
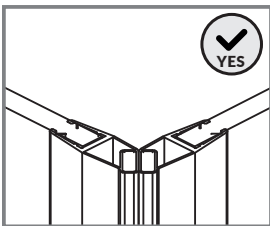
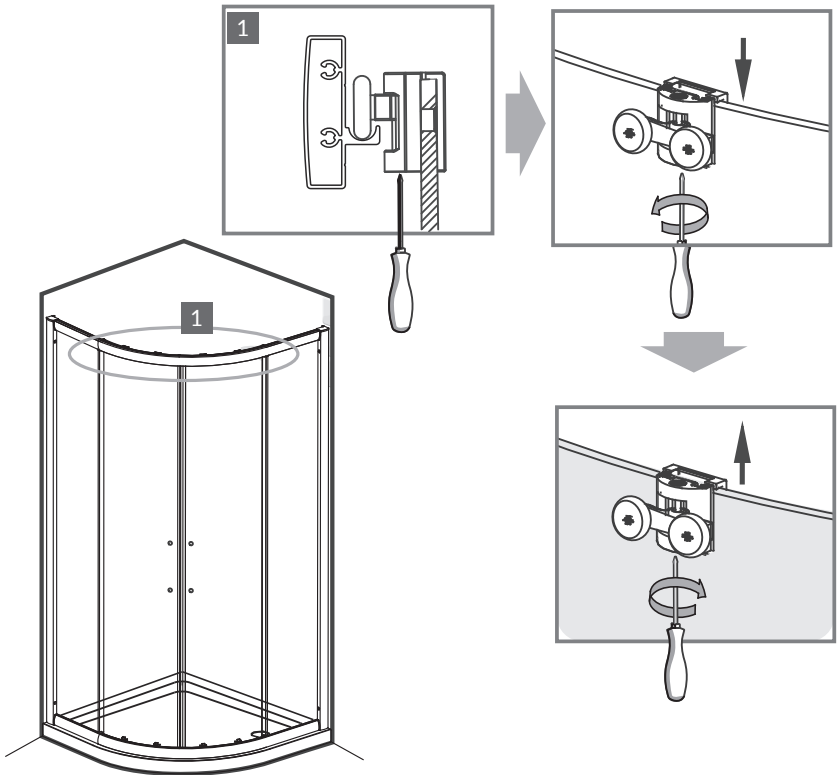

➕ PH2



17.

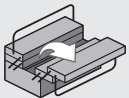
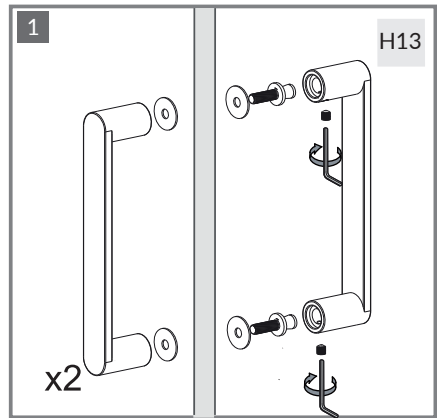
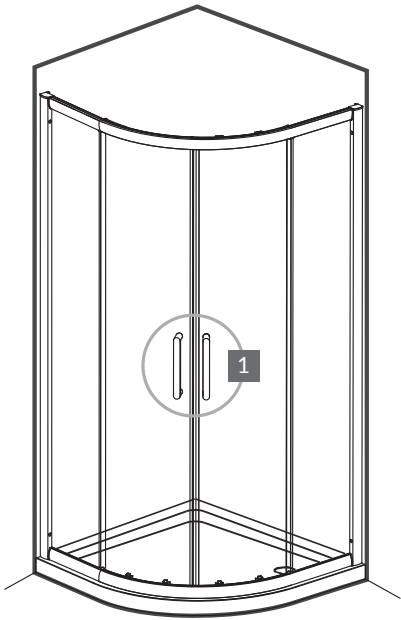

H13

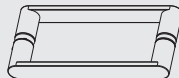

x2



18.

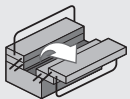
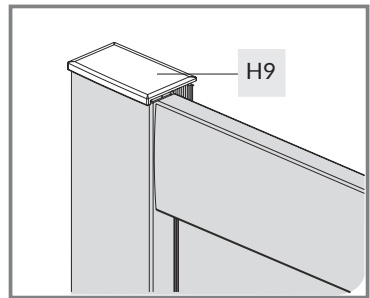
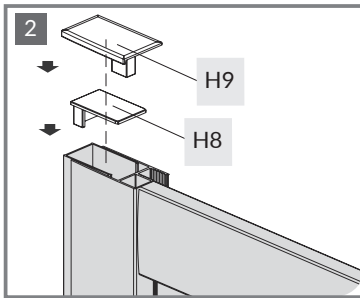
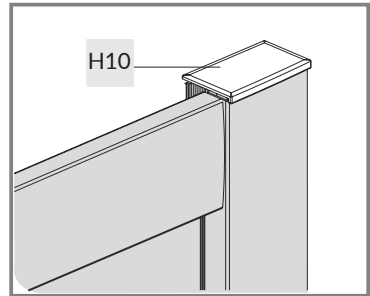
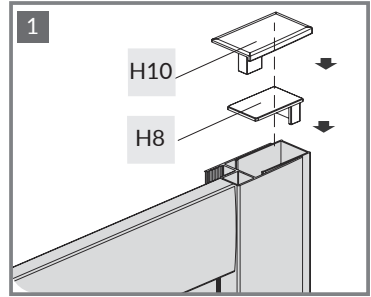
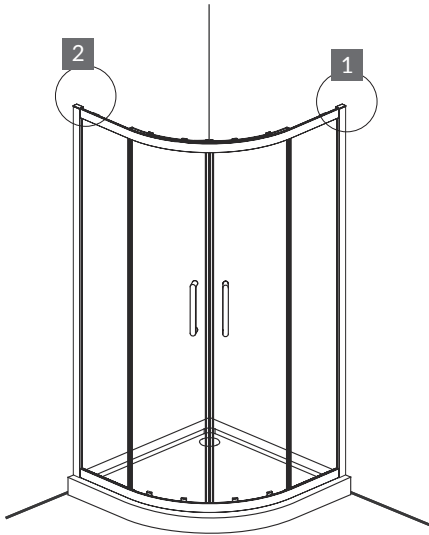

H8



x2

H9



x1

H10



x1



19.

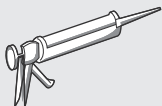
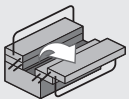
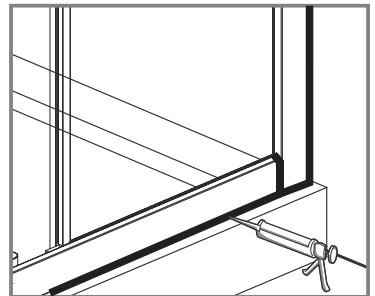
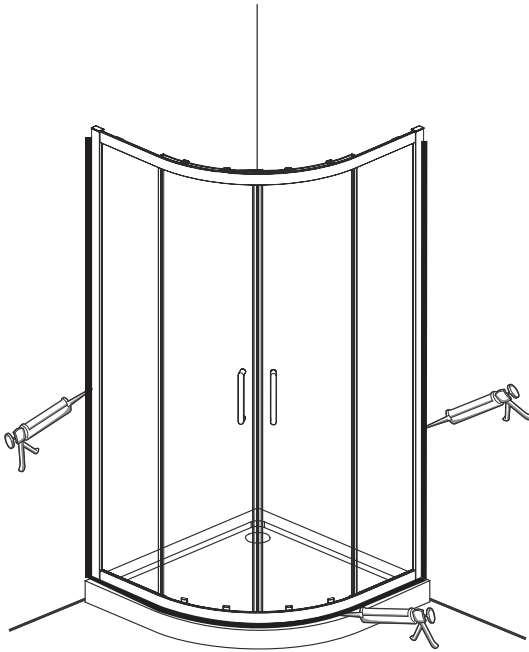



6.5<PH<7.5

