













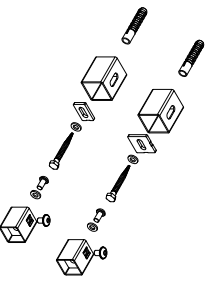









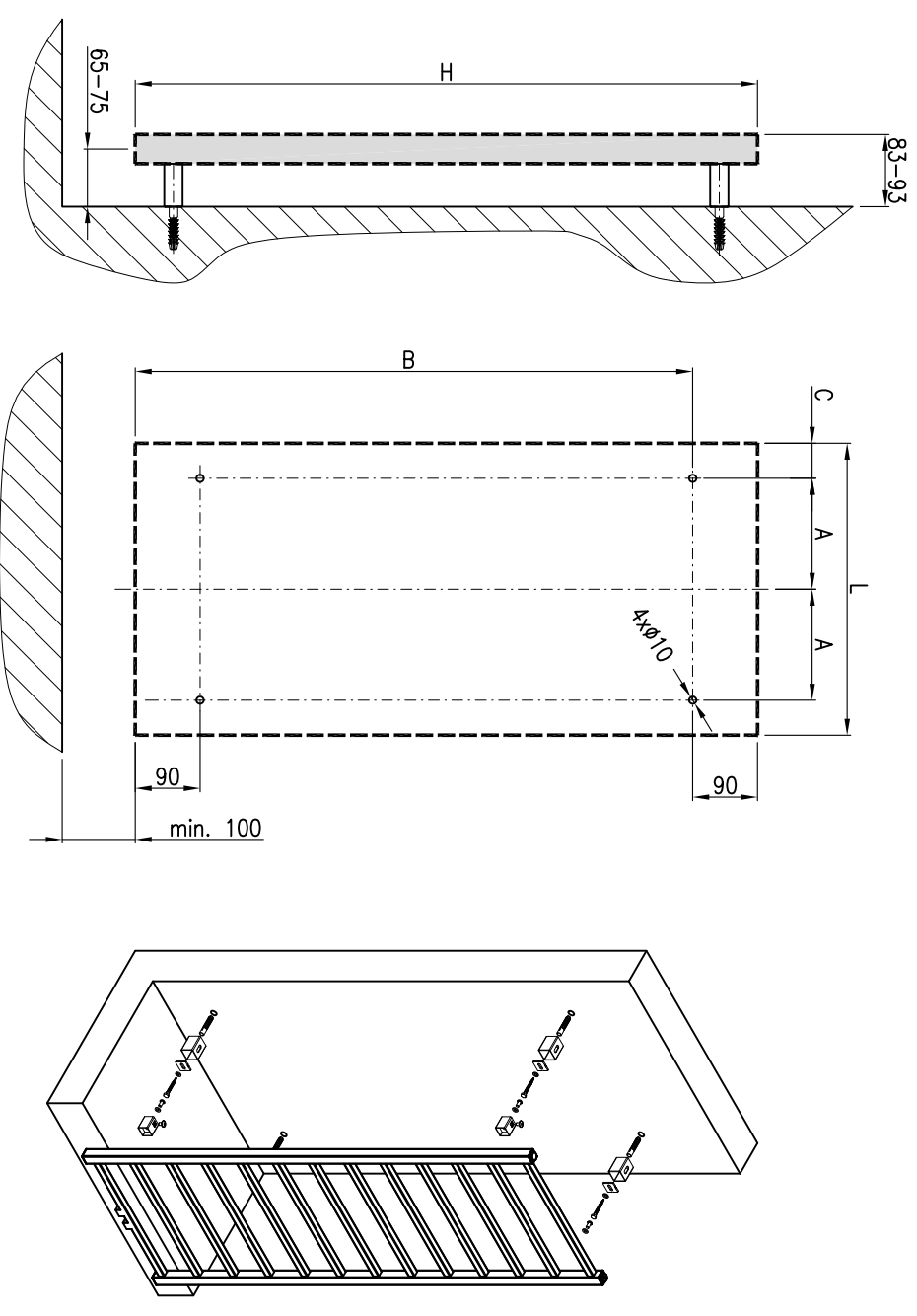
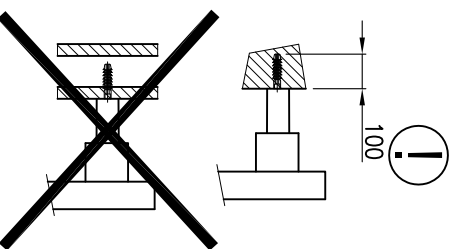

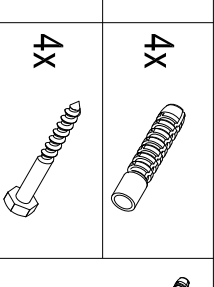
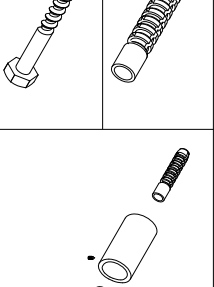

4X 	4X 	4X 	4X 	2X 	
4X 	4X 	4X 	4X 	2X 	
4X 	4X 	4X 	2X 	2X 	

H/L [mm]	A [mm]	B [mm]	C [mm]
1100/500	235	1010	20
1430/550	285	1340	20

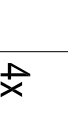

4X 	4X 	4X 	4X 	
4X 	4X 	4X 	4X 	
4X 	4X 	4X 	4X 	

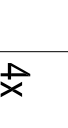
H/L [mm]	A [mm]	B [mm]	C [mm]
1140/300	135	1050	15
1140/400	185	1050	15
1500/300	135	1410	15
1500/400	185	1410	15

